

SANYO

Multimedia Projector

MODEL PLV-Z3

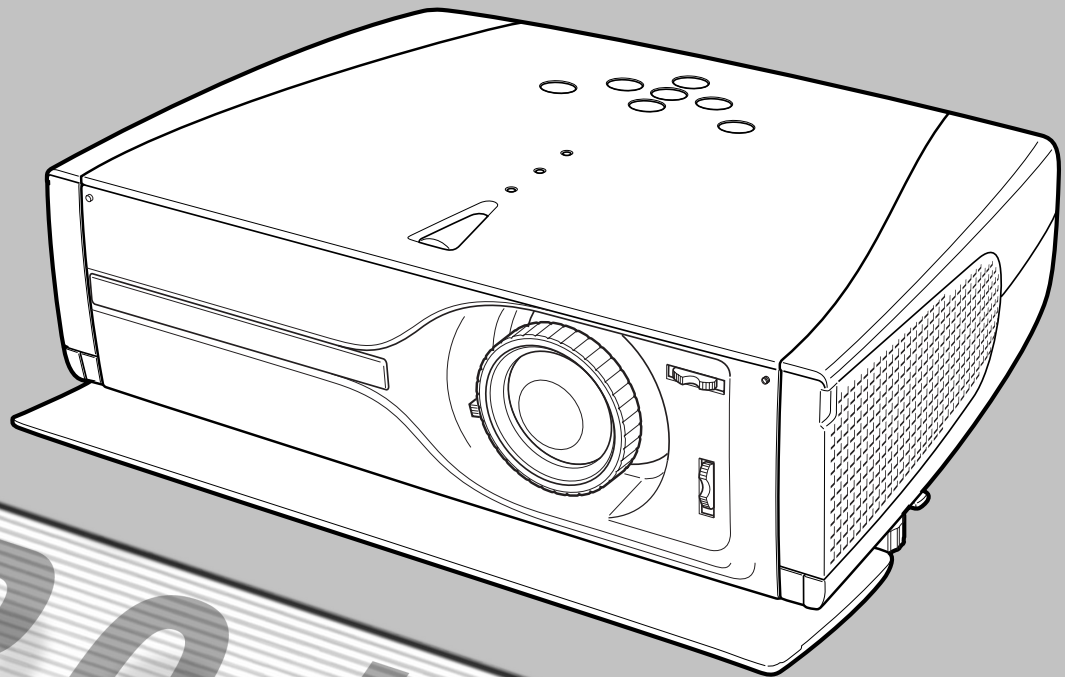

PROJECTOR

Owner's Manual

Features and Design

This Multimedia Projector is designed with the most advanced technology for portability, durability, and ease of use. This projector utilizes built-in multimedia features, a palette of 16.77 million colors, and matrix liquid crystal display (LCD) technology.

◆ Short Zoom Lens

This projector is equipped with Short Zoom Lens which allows you to enjoy 100" screen size in range of 9.8' (3.0m) to 13.1' (4.0m).

◆ Lens Shift

The Lens Shift function gives you less limitation in positioning the projector. You can use it at desired places without a distorted image.

◆ Advanced Picture Adjustment

The projector provides additional function to reproduce professional like fine pictures. Using the function, details of the picture can be adjusted.

◆ Compatibility

The projector widely accepts various video and computer input signals including; Computers, 6 Color systems, Component video, S-video, RGB scart and HDMI.

◆ Simple Computer System Setting

The projector has the Multi-scan system to conform to almost all computer output signals quickly. (See page 33.)

◆ 16 : 9 Wide Screen

The projector is equipped with LCD panels (1280 x 720 resolution) of 16 : 9 ratio so that you can project the image from component video signal such as a DVD player and high definition TV in a full screen.

◆ Interlace Progressive Conversion

High-quality picture is available with this technology which converts interlace signal into progressive signal. (See page 29.)

◆ Wide Selection of Image Levels

You can select an ideal image level suitable for the surroundings or your desired picture quality. (See page 27,37.) 4 different your choices of images can also be stored. (See page 28-29,38-39.)

◆ Keystone Adjustment

Keystone distortion function is provided to correct distortion of the projected image allowing you to use the projector without locational constraints. (See page 21 and 41.)

◆ Power Management

The Power management function reduces power consumption and maintain the lamp life. (See page 43.)

◆ My Picture

A projected image can be captured and used for the starting display of the projector with the Capture function. You can also display the captured image whenever you want to with the MY PICTURE (MY-P) button on the remote control. (See page 11, 21, 42.)

◆ Lamp Mode

Brightness of the projection lamp can be changed by setting. The projector has the function to adjust the brightness according to an input signal for the best suited image. (See page 29,39.)

◆ Multilanguage Menu Display

Operation menu is available in; English, German, French, Italian, Spanish, Portuguese, Dutch, Swedish, Russian, Chinese, Korean, or Japanese. (See page 41.)

◆ Selectable Setting Position

Mounting function provides proper image position (up/down and left/right) depending on the setting position of the projector such as ceiling mounting or wall-hung. (See page 42)

◆ High Definition Multimedia Interface

The projector is equipped with HDMI terminal for connecting HDMI output from a video equipment. Simple connection with digital equipment is offered through this terminal.

Table of Contents

Features and Design	2	Video Input	24
Table of Contents	3	Input Source Selection (Video, S-Video, Component1/2,HDMI)	24
To the Owner	4	Video System Selection	26
Safety Instructions	5	Image Level Selection	27
Air Circulation	6	Image Level Adjustment	28
Installing the Projector in Proper Position	6	Screen Size Adjustment	30
Moving the Projector	6	Computer Input	32
Compliance	7	Input Source Selection	32
Part Names and Functions	8	Computer System Selection	33
Front	8	Computer Adjustment (Auto)	34
Back	8	Computer Adjustment (Manual)	35
Bottom	8	Image Level Selection	37
Terminal	9	Image Level Adjustment	38
Top	10	Screen Size Adjustment	40
Remote Control	11	Setting	41
Remote Control Operating Range	12	Setting	41
Remote Control Batteries Installation	12	Maintenance and Cleaning	45
Installation	13	Warning Indicator	45
Positioning the Projector	13	Cleaning the RGB panels	46
Adjustable Feet	13	Cleaning the Air Filter	48
Connecting the AC Power Cord	14	Replacing the Air Filter	49
Moving the Lens	15	Cleaning the Projection Lens	49
Connecting to Video Equipment (Video, S-Video)	16	Cleaning the Projector Cabinet	49
Connecting to Video Equipment (Component)	16	Lamp Replacement	50
Connecting to Video Equipment (HDMI)	17	Lamp Replace Counter	51
Connecting to Video Equipment (RGB Scart)	17	Appendix	52
Connecting to a Computer	18	Troubleshooting	52
Basic Operation	19	Indicators and Projector Condition	53
Turning On the Projector	19	Menu Tree	54
Turning Off the Projector	19	Compatible Computer Specifications	56
Zoom Adjustment	20	Technical Specifications	57
Focus Adjustment	20	Dimensions	58
Keystone Adjustment	21	Configurations of Terminal	59
My Picture Function	21	Optional Parts	59
No Show Function	21		
On-Screen Menu	22		
Menus	23		

TRADEMARKS

- Apple, Macintosh, and PowerBook are trademarks or registered trademarks of Apple Computer, Inc.
- IBM, VGA, XGA, and PS/2 are trademarks or registered trademarks of International Business Machines, Inc.
- Windows and PowerPoint are registered trademarks of Microsoft Corporation.
- Each name of corporations or products in the owner's manual is a trademark or a registered trademark of its respective corporation.





To the Owner

Before operating this projector, read this manual thoroughly and operate the projector properly.

This projector provides many convenient features and functions. Operating the projector properly enables you to manage those features and maintains it in better condition for a considerable time.

Improper operation may result in not only shortening the product-life, but also malfunctions, fire hazard, or other accidents.

If your projector seems to operate improperly, read this manual again, check operations and cable connections and try the solutions in the "Troubleshooting" section in the end of this booklet. If the problem still persists, contact the dealer where you purchased the projector or the service center.

	CAUTION RISK OF ELECTRIC SHOCK DO NOT OPEN	
CAUTION : TO REDUCE THE RISK OF ELECTRIC SHOCK, DO NOT REMOVE COVER (OR BACK). NO USER-SERVICEABLE PARTS INSIDE EXCEPT LAMP REPLACEMENT. REFER SERVICING TO QUALIFIED SERVICE PERSONNEL.		
	THIS SYMBOL INDICATES THAT DANGEROUS VOLTAGE CONSTITUTING A RISK OF ELECTRIC SHOCK IS PRESENT WITHIN THIS UNIT.	
	THIS SYMBOL INDICATES THAT THERE ARE IMPORTANT OPERATING AND MAINTENANCE INSTRUCTIONS IN THE OWNER'S MANUAL WITH THIS UNIT.	



Safety Precaution

WARNING : TO REDUCE THE RISK OF FIRE OR ELECTRIC SHOCK, DO NOT EXPOSE THIS APPLIANCE TO RAIN OR MOISTURE.

- This projector produces intense light from the projection lens. Do not stare directly into the lens as possible. Eye damage could result. Be especially careful that children do not stare directly into the beam.
- Install the projector in a proper position. If not, it may result in a fire hazard.
- Provide appropriate space on the top, sides and rear of the projector cabinet for allowing air circulation and cooling the projector. Minimum clearance must be maintained. If the projector is to be built into a compartment or similarly enclosed, the minimum distances must be maintained. Do not cover the ventilation slot on the projector. Heat build-up can reduce the service life of your projector, and can also be dangerous.

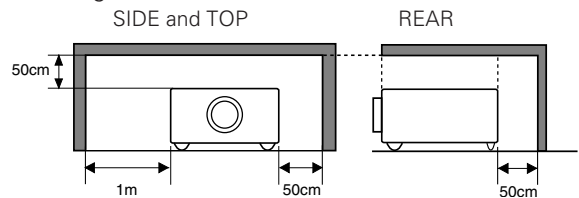

- Do not put any flammable object or spray can near the projector, hot air is exhausted from the ventilation holes.
- If the projector is not to be used for an extended time, unplug the projector from the power outlet.

READ AND KEEP THIS OWNER'S MANUAL FOR LATER USE.

CAUTION

Not for use in a computer room as defined in the Standard for the Protection of Electronic Computer/Data Processing Equipment, ANSI/NFPA 75.

Ne puet être utilisé dans une salle d'ordinateurs telle que définie dans la norme ANSI/NFPA 75 Standard for Protection of Electronic Computer/Data Processing Equipment

Safety Instructions

All the safety and operating instructions should be read before the product is operated.

Read all of the instructions given here and retain them for later use. Unplug this projector from AC power supply before cleaning. Do not use liquid or aerosol cleaners. Use a damp cloth for cleaning.

Follow all warnings and instructions marked on the projector.

For added protection to the projector during a lightning storm, or when it is left unattended and unused for long periods of time, unplug it from the wall outlet. This will prevent damage due to lightning and power line surges.

Do not expose this unit to rain or use near water... for example, in a wet basement, near a swimming pool, etc...

Do not use attachments not recommended by the manufacturer as they may cause hazards.

Do not place this projector on an unstable cart, stand, or table. The projector may fall, causing serious injury to a child or adult, and serious damage to the projector. Use only with a cart or stand recommended by the manufacturer, or sold with the projector. Wall or shelf mounting should follow the manufacturer's instructions, and should use a mounting kit approved by the manufacturers.

An appliance and cart combination should be moved with care. Quick stops, excessive force, and uneven surfaces may cause the appliance and cart combination to overturn.



Slots and openings in the back and bottom of the cabinet are provided for ventilation, to insure reliable operation of the equipment and to protect it from overheating.

The openings should never be covered with cloth or other materials, and the bottom opening should not be blocked by placing the projector on a bed, sofa, rug, or other similar surface. This projector should never be placed near or over a radiator or heat register.

This projector should not be placed in a built-in installation such as a book case unless proper ventilation is provided.

Never push objects of any kind into this projector through cabinet slots as they may touch dangerous voltage points or short out parts that could result in a fire or electric shock. Never spill liquid of any kind on the projector.

Do not install the projector near the ventilation duct of air-conditioning equipment.

This projector should be operated only from the type of power source indicated on the marking label. If you are not sure of the type of power supplied, consult your authorized dealer or local power company.

Do not overload wall outlets and extension cords as this can result in fire or electric shock. Do not allow anything to rest on the power cord. Do not locate this projector where the cord may be damaged by persons walking on it.

Do not attempt to service this projector yourself as opening or removing covers may expose you to dangerous voltage or other hazards. Refer all servicing to qualified service personnel.

Unplug this projector from wall outlet and refer servicing to qualified service personnel under the following conditions:

- a. When the power cord or plug is damaged or frayed.
- b. If liquid has been spilled into the projector.
- c. If the projector has been exposed to rain or water.
- d. If the projector does not operate normally by following the operating instructions. Adjust only those controls that are covered by the operating instructions as improper adjustment of other controls may result in damage and will often require extensive work by a qualified technician to restore the projector to normal operation.
- e. If the projector has been dropped or the cabinet has been damaged.
- f. When the projector exhibits a distinct change in performance-this indicates a need for service.

When replacement parts are required, be sure the service technician has used replacement parts specified by the manufacturer that have the same characteristics as the original part. Unauthorized substitutions may result in fire, electric shock, or injury to persons.

Upon completion of any service or repairs to this projector, ask the service technician to perform routine safety checks to determine that the projector is in safe operating condition.



Voor de klanten in Nederland

Bij dit produkt zijn batterijen geleverd. Wanneer deze leeg zijn, moet u ze niet weggooien maar inleveren als KCA.



Safety Instructions

Air Circulation

Openings in the cabinet are provided for ventilation and to ensure reliable operation of the product and to protect it from overheating, and these openings must not be blocked or covered.



CAUTION

Hot air is exhausted from the exhaust vent. When using or installing the projector, the following precautions should be taken.

- Do not put any flammable objects near the vent.
- Keep the exhaust vent at least 1.5'(50cm) away from any objects.
- Do not touch a peripheral part of the exhaust vent, especially screws and metallic part. This area will become hot while the projector is being used.
- Do not put anything on the cabinet. The materials put on the cabinet will not only get damaged but also cause fire hazard by heat.

Cooling fans are provided to cool down the projector. This projector monitors internal temperature and control the running speed of the cooling fans.

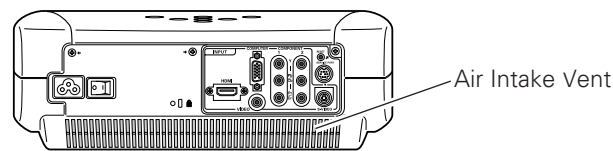
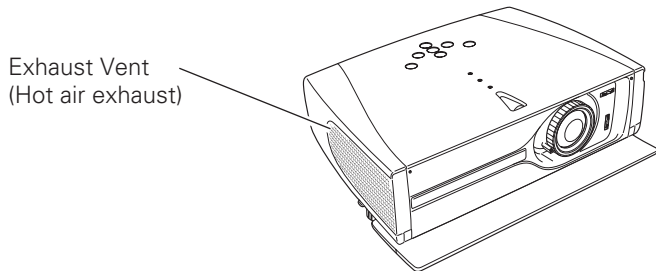

Installing the Projector in Proper Position

Install the projector properly. Improper Installation may reduce the lamp lifetime and cause a fire hazard.

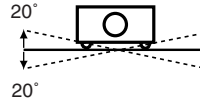

Do not tilt the projector more than 20 degrees to either side.



Do not point the projector down to project an image.

NO DOWNWARD



Do not put the projector on either side to project an image.

NO SIDEWARD

Moving the Projector

When moving the projector, close the front cover and retract the adjustable feet to prevent damage to the lens and cabinet. When the projector is not in use for an extended period, put it into a suitable case.



CAUTION IN CARRYING OR TRANSPORTING THE PROJECTOR

- Do not drop or bump a projector, otherwise damages or malfunctions may result.
- When carrying a projector, use a suitable carrying case.
- Do not transport a projector by using a courier or transport service in an unsuitable transport case. This may cause damage to a projector. To transport a projector through a courier or transport service, consult your dealer for best way.

Compliance

Federal Communication Commission Notice

Note : This equipment has been tested and found to comply with the limits for a Class B digital device, pursuant to part 15 of the FCC Rules. These limits are designed to provide reasonable protection against harmful interference in a residential installation. This equipment generates, uses and can radiate radio frequency energy and, if not installed and used in accordance with the instructions, may cause harmful interference to radio communications. However, there is no guarantee that interference will not occur in a particular installation. If this equipment does cause harmful interference to radio or television reception, which can be determined by turning the equipment off and on, the user is encouraged to try to correct the interference by one or more of the following measures :

- Reorient or relocate the receiving antenna.
- Increase the separation between the equipment and receiver.
- Connect the equipment into an outlet on a circuit different from that to which the receiver is connected.
- Consult the dealer or an experienced radio/TV technician for help.

Use of shielded cable is required to comply with class B limits in Subpart B of Part 15 of FCC Rules.

Do not make any changes or modifications to the equipment unless otherwise specified in the instructions. If such changes or modifications should be made, you could be required to stop operation of the equipment.

Model Numbers : PLV-Z3
Trade Name : Sanyo
Responsible party : SANYO FISHER COMPANY
Address : 21605 Plummer Street, Chatsworth, California 91311
Telephone No. : (818)998-7322

AC POWER CORD REQUIREMENT

The AC Power Cord supplied with this projector meets the requirement for use in the country you purchased it.

AC Power Cord for the United States and Canada :

AC Power Cord used in the United States and Canada is listed by the Underwriters Laboratories (UL) and certified by the Canadian Standard Association (CSA).

AC Power Cord has a grounding-type AC line plug. This is a safety feature to be sure that the plug will fit into the power outlet. Do not try to defeat this safety feature. Should you be unable to insert the plug into the outlet, contact your electrician.

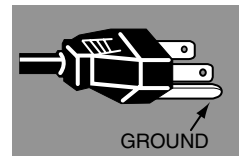

AC Power Cord for the United Kingdom :

This cord is already fitted with a moulded plug incorporating a fuse, the value of which is indicated on the pin face of the plug. Should the fuse need to be replaced, an ASTA approved BS 1362 fuse must be used of the same rating, marked thus \diamond . If the fuse cover is detachable, never use the plug with the cover omitted. If a replacement fuse cover is required, ensure it is of the same colour as that visible on the pin face of the plug (i.e. red or orange). Fuse covers are available from the Parts Department indicated in your User Instructions.

If the plug supplied is not suitable for your socket outlet, it should be cut off and destroyed.

The end of the flexible cord should be suitably prepared and the correct plug fitted. (See Over)

WARNING : A PLUG WITH BARED FLEXIBLE CORD IS HAZARDOUS IF ENGAGED IN A LIVE SOCKET OUTLET.

The Wires in this mains lead are coloured in accordance with the following code:

Green-and-yellow Earth
Blue Neutral
Brown Live

As the colours of the wires in the mains lead of this apparatus may not correspond with the coloured markings identifying the terminals in your plug proceed as follows:

The wire which is coloured green-and-yellow must be connected to the terminal in the plug which is marked by the letter E or by the safety earth symbol \perp or coloured green or green-and-yellow.

The wire which is coloured blue must be connected to the terminal which is marked with the letter N or coloured black.

The wire which is coloured brown must be connected to the terminal which is marked with the letter L or coloured red.

WARNING : THIS APPARATUS MUST BE EARTHED.

THE SOCKET-OUTLET SHOULD BE INSTALLED NEAR THE EQUIPMENT AND EASILY ACCESSIBLE.

Part Names and Functions

Front

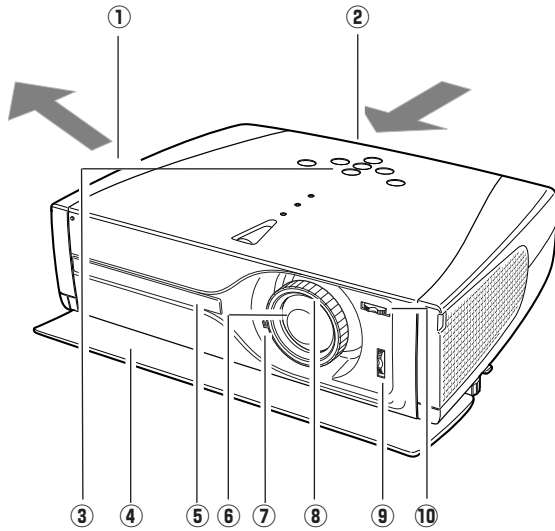

① Exhaust Vent



CAUTION

Hot air is exhausted from the exhaust vent. Do not put heat-sensitive objects near this side.

② Air Intake Vent (The two arrows show air flow.)

③ Top Controls and Indicators

④ Front Cover

⑤ Infrared Remote Receiver

⑥ Projection Lens

⑦ Zoom Lever

⑧ Focus Ring

⑨ Lens Shift Ring (Up/Down)

⑩ Lens Shift Ring (Left/Right)

Back

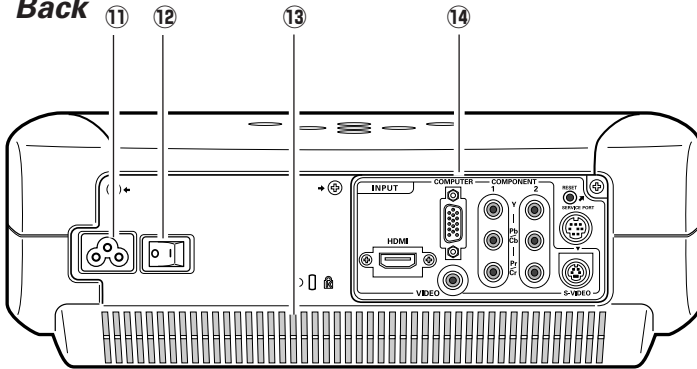

⑪ Power Cord Connector

⑫ Main On/Off Switch

⑬ Air Intake Vent

⑭ Terminals and Connectors

Bottom

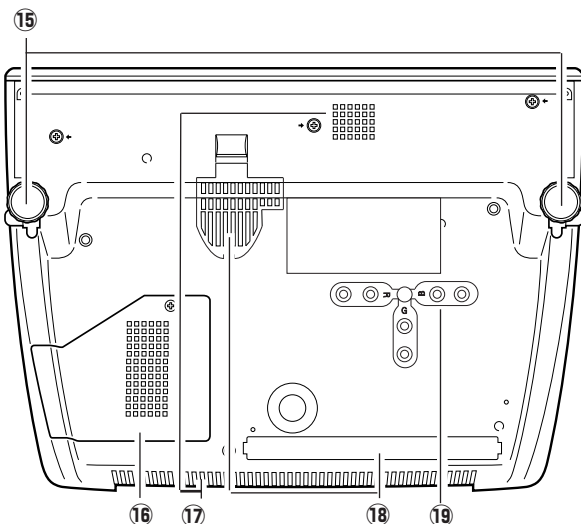

⑮ Adjustable Feet

⑯ Lamp Cover

⑰ Air Intake Vent (back and bottom)

⑱ Air Filter

⑲ RGB Panel Cleaning Holes

Terminal

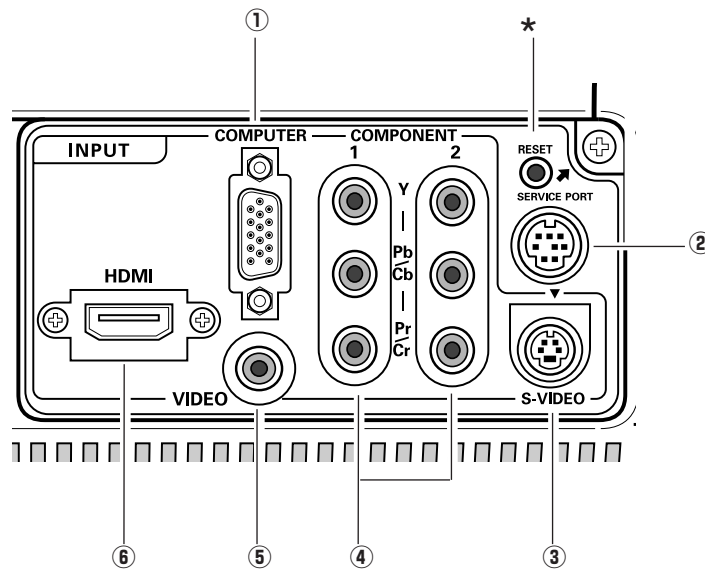

① COMPUTER

Connect computer output, or RGB Scart 21-pin video output to this connector. (p17,18)

② SERVICE PORT

This jack is used to service this projector.

③ S-VIDEO

Connect the S-Video output from video equipment to this jack. (p16)

④ COMPONENT 1 / 2

Connect the component video output to these jacks. (p16)

⑤ VIDEO

Connect the composite video output from video equipment to this jack. (p16)

⑥ HDMI

Connect the HDMI from video equipment to this terminal. (p17)

* A built-in micro processor which controls this unit may occasionally malfunction and need to be reset. This can be done by pressing the RESET button with a pen, which will shut down and restart the unit. Do not use the RESET function excessively.

Top

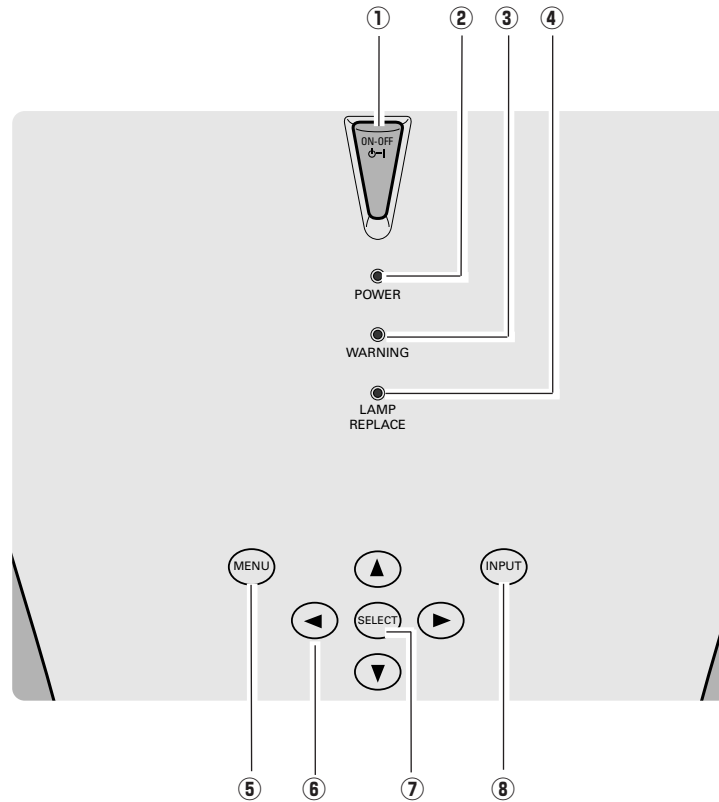

- ① POWER ON-OFF button**
Turns the projector on or off. (p19)
- ② POWER indicator**
Flashes red until the projector gets ready to be turned on. It lights red when the projector is in the stand-by mode. It remains green while the projector is under operation. When the front cover is closed it lights orange.
- ③ WARNING indicator**
Lights red when the projector detects abnormal condition. This also flashes red when the internal temperature of the projector exceeds the operating range. (p45)
- ④ LAMP REPLACE indicator**
Turns yellow when the life of the projection lamp draws to an end. (p49)
- ⑤ MENU button**
Opens or closes the On-Screen Menu. (p22)
- ⑥ POINT (Up▲/Down▼/Left◀/Right▶) button**
Selects an item or adjusts value in the On-Screen Menu. These are also used to pan the image in the Digital zoom mode. (p40)
- ⑦ SELECT button**
Executes the item selected. It is also used to expand / compress the image in Digital zoom mode. (p40)
- ⑧ INPUT button**
Selects input source. (p24, 32)

Remote Control

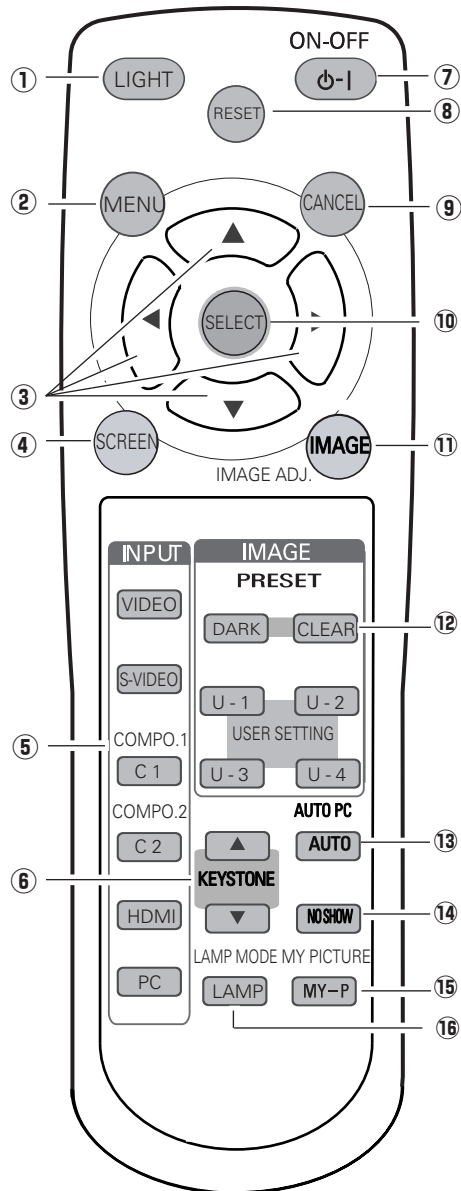

- ① **LIGHT button**
Lights the buttons on the remote control for about 10 seconds.
- ② **MENU button**
Opens or closes the On-Screen Menu. (p22)
- ③ **POINT (UP/DOWN/LEFT/RIGHT) button**
Selects an item or adjusts value in the On-Screen Menu. These are also used to pan the image in the Digital zoom mode. (p40)
- ④ **SCREEN button**
Selects a screen size. (p30, 31, 40)
- ⑤ **INPUT buttons**
Selects input source. (p24, 32)
- ⑥ **KEystone buttons**
Corrects keystone distortion. (p21, 41)
- ⑦ **POWER ON-OFF button**
Turns the projector on or off. (p19)
- ⑧ **RESET button**
Resets to the previous figure.
When selecting main menu, all the items will be reset. When selecting sub-menu, the selected item will be reset. This button works when selecting Image level adjustment, Computer adjustment (Manual), Keystone and Digital zoom function.
- ⑨ **CANCEL button**
Goes back to the previous screen. When there is no previous screen to go back, displaying screen will disappear.
- ⑩ **SELECT button**
Executes the item selected, or to expand or compress image in the Digital zoom mode. (p40)
- ⑪ **IMAGE ADJ. button**
Displays the On-Screen Menu of the Image Adjust Menu in a line and adjusts image level. You can directly adjust an item. (p28, 29, 38,39)
- ⑫ **IMAGE buttons**
Selects an Image Level.(p27, 37)
- ⑬ **AUTO PC button**
Operates the Auto PC adjustment function. (p34)
- ⑭ **NO SHOW button**
Turns the picture into black image. (p21)
- ⑮ **MY PICTURE button**
Displays the captured image. (p21,42)
- ⑯ **LAMP button**
Selects a lamp mode. (p29,39)

Remote Control Operating Range

Point the remote control toward the projector (Infrared Remote Receiver) whenever pressing any button. Maximum operating range for the remote control is about 16.4' (5m) and 60° in front of the projector.

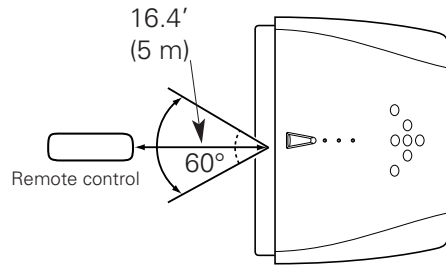

Remote Control Batteries Installation

- 1** Remove the battery compartment lid.

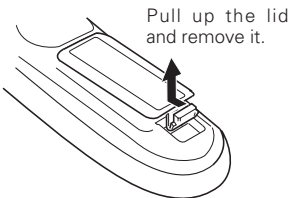

- 2** Slide the batteries into compartment.

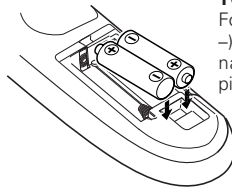

Two AA size batteries
For correct polarity (+ and -), be sure battery terminals are in contact with pins in compartment.

- 3** Replace the compartment lid.

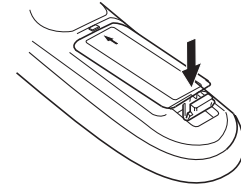

* When the batteries of the remote control are replaced, the remote control code automatically returns to the initial code (Code 1)(p43).



To insure safe operation, please observe the following precautions :

- Use (2) AA, UM3 or LR06 type alkaline batteries.
- Replace two batteries at the same time.
- Do not use a new battery with a used battery.
- Avoid contact with water or liquid.
- Do not expose the remote control to moisture, or heat.
- Do not drop the remote control.
- If a battery has leaked on remote control, carefully wipe case clean and install new batteries.
- Risk of explosion if battery is replaced by an incorrect type.
- Dispose of used batteries according to the instructions.

Installation

Positioning the Projector

This projector is designed to project on a flat projection surface and can be focused from 3.9'(1.2m) - 20.0'(6.1m). Refer to the figure and the table below for the screen size and the distance between the projector and the screen.

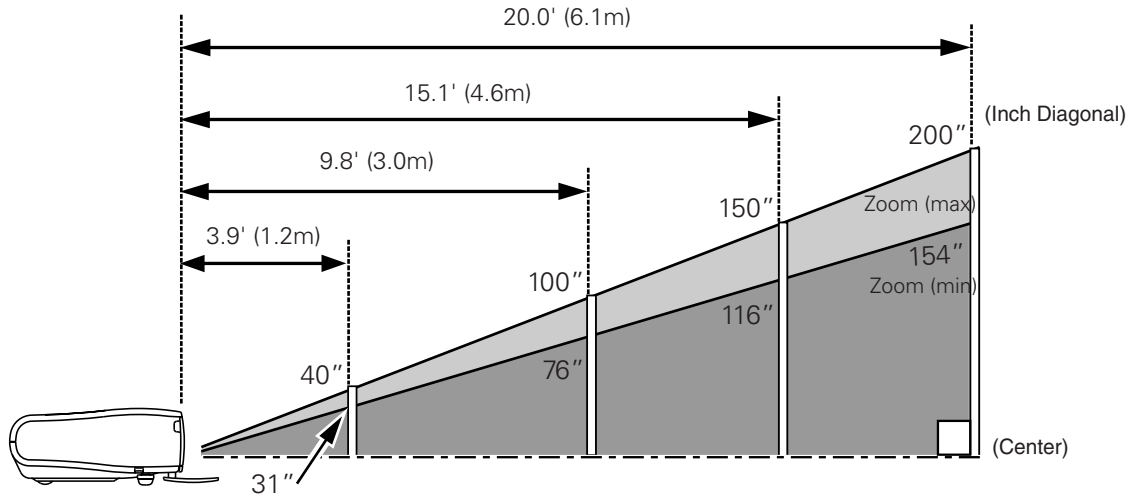

Screen Size (W x H) mm	31"	40"	100"	150"	200"
16 : 9 aspect ratio	686 x 386	884 x 497	2209 x 1244	3314 x 1866	4419 x 2489
Zoom (min)	3.9' (1.2m)	5.2' (1.6m)	13.1' (4.0m)	19.3' (5.9m)	—
Zoom (max)	—	3.9' (1.2m)	9.8' (3.0m)	15.1' (4.6m)	20.0' (6.1m)

NOTE

- The brightness in a room has a great influence on picture quality. It is recommended to limit ambient lighting in order to provide the best image.
- The values shown are approximate and may vary from the actual size.

Adjustable Feet

Projection angle can be adjusted up to 11.8 degrees with the adjustable feet.

- 1 Lift the front of the projector and pull the foot lock latches on both sides of the projector.
- 2 Release the foot lock latches to lock the adjustable feet and rotate the adjustable feet to adjust the position and tilt.
- 3 To retract the adjustable feet, lift the front of the projector and pull and undo the foot lock latches.
Keystone distortion of the projected image can be adjusted by menu operation. (p21, 41)



CAUTION

Tilt the projector within the adjustable range in order not to shorten the life of the lamp. Proper angle should be taken. See page 6.

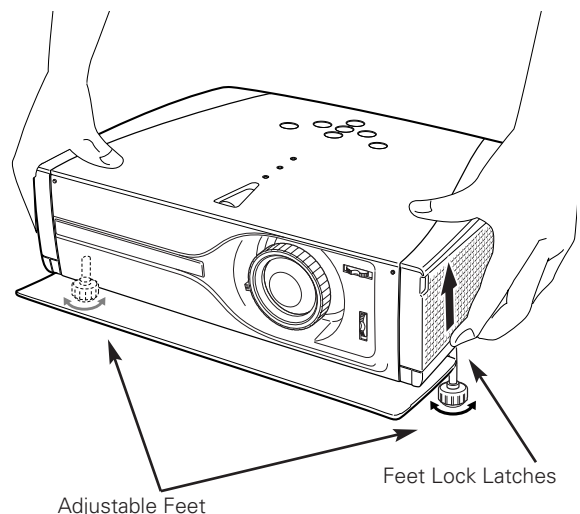

Connecting the AC Power Cord

This projector uses nominal input voltages of 100-120 V or 200-240 V AC. This projector automatically selects the correct input voltage. It is designed to work with single-phase power systems having a grounded neutral conductor. To reduce risk of electrical shock, do not plug into any other type of power system. Consult your authorized dealer or service station if you are not sure of the type of power being supplied. Connect the projector with all peripheral equipment before turning the projector on. (See page 16-18 for connection.)



CAUTION

For safety, unplug AC power cord when the projector is not in use.

When this projector is connected to the outlet with AC power cord and the Main On/Off switch is on, it is in Stand-by mode and consumes a little electric power. Turn the Main On/Off switch off when the projector is not in use.

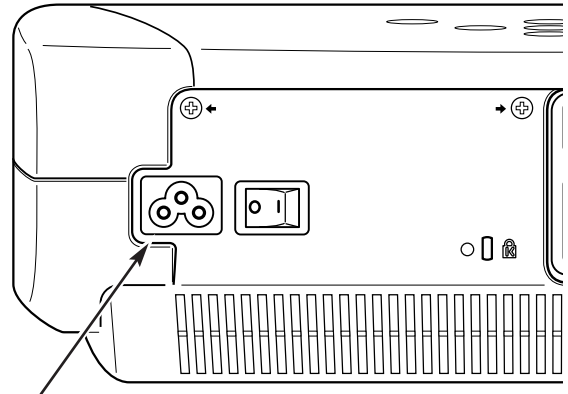

Connect AC power cord (supplied) to the projector. The AC outlet must be near this equipment and must be easily accessible.

NOTE ON THE POWER CORD

AC power cord must meet requirement of the country where you use a projector. Confirm an AC plug type with the chart below and proper AC power cord must be used. If supplied AC power cord does not match your AC outlet, contact your sales dealer.

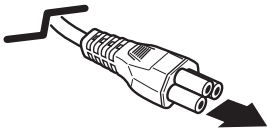
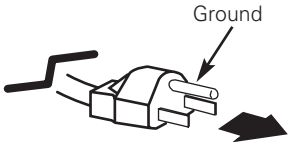
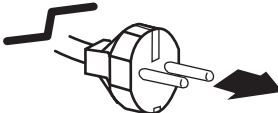
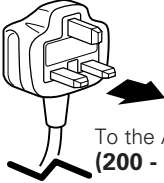
Projector side	AC outlet side		
 <p data-bbox="240 1339 461 1388">To power cord connector on your projector.</p>	<p data-bbox="493 1136 792 1163">For the U.S.A. and Canada</p>  <p data-bbox="623 1346 786 1394">To the AC outlet. (120 V AC)</p>	<p data-bbox="829 1136 1117 1163">For Continental Europe</p>  <p data-bbox="948 1360 1127 1409">To the AC outlet. (200 - 240 V AC)</p>	<p data-bbox="1230 1136 1386 1163">For the U.K.</p>  <p data-bbox="1279 1339 1458 1388">To the AC outlet. (200 - 240 V AC)</p>

Moving the Lens

The projection lens can be moved up, down, left, and right with the manual lens shift function. This function makes it easy to provide a projected image where you want.

Turn the lens shift ring (left/right) left/right to move the lens leftward / rightward.

Turn the lens shift ring (up/down) up/down to move the lens upward / downward.

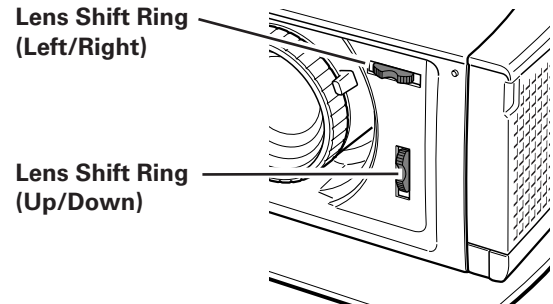

Lens Shift Up/Down

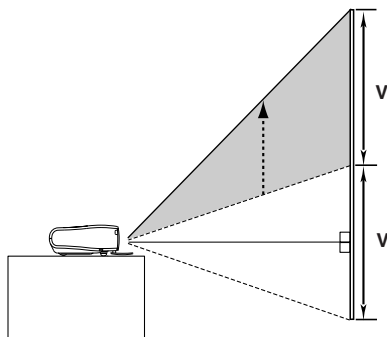

uppermost

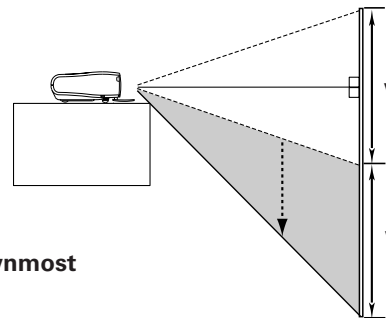

downmost

Lens Shift Left/Right

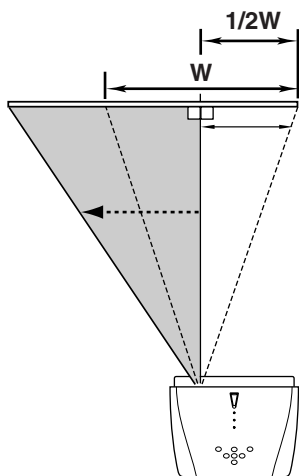

leftmost

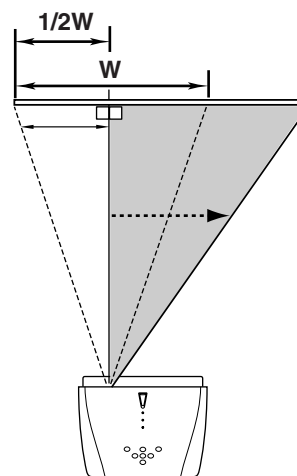

rightmost

NOTE

- The best image is generally obtained at the center of the lens shift.
- When using the lens shift upward or downward to the limit, the lens does not move to the limit leftward or rightward. When using the lens shift leftward or rightward to the limit, the lens does not move to the limit upward or downward.

Connecting to Video Equipment (Video, S-Video)

Video, S-video

Use the supplied video cable or a s-video cable (not supplied).

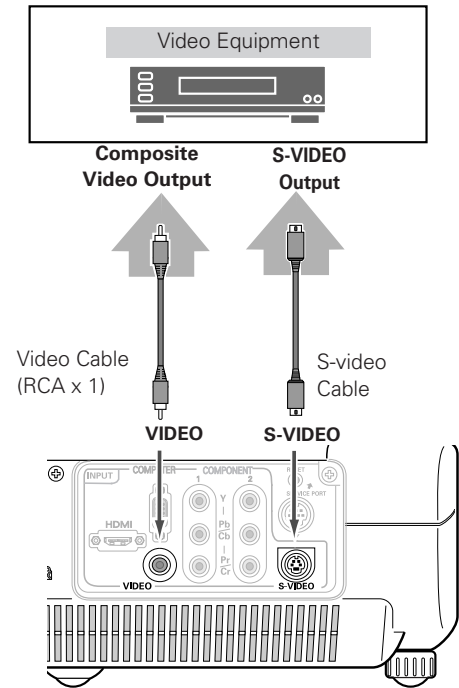

Connecting to Video Equipment (Component)

Component

Use a component cable (option).

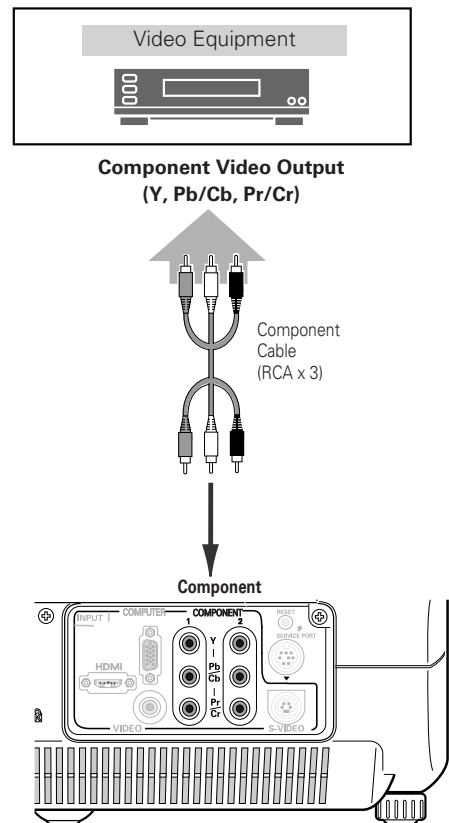

NOTE

- See page 59 for ordering optional cables.



NOTE
When connecting the cable, the power cords of both the projector and the external equipment should be disconnected from AC outlet.

Connecting to Video Equipment (HDMI)

HDMI

Use a HDMI cable (option) for HDMI.

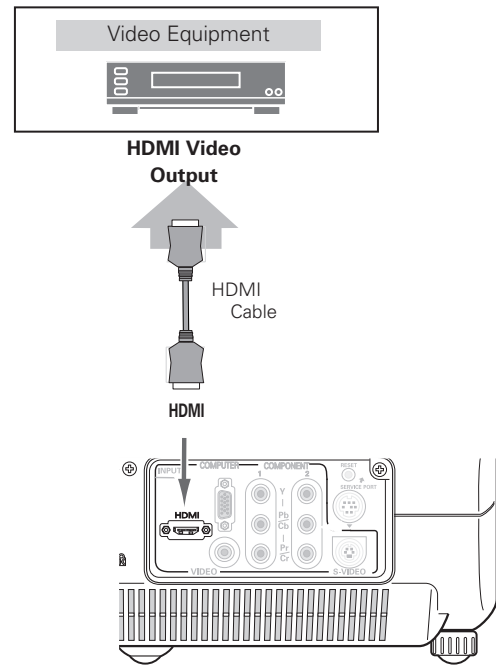

Connecting to Video Equipment (RGB Scart)

RGB Scart

Use a Scart-VGA cable (option).

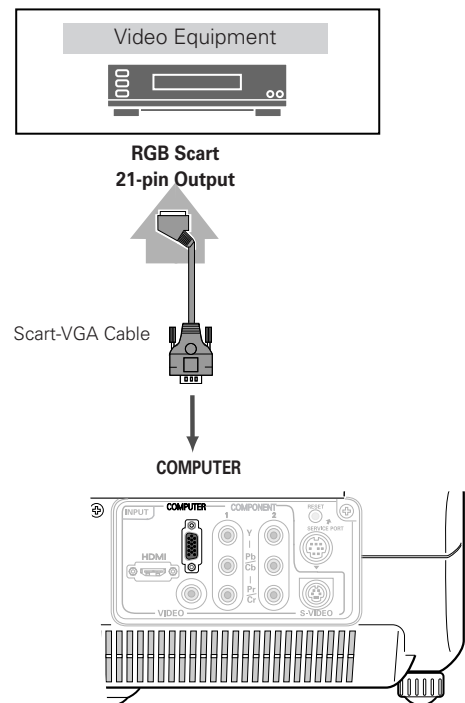

NOTE

- See page 59 for ordering optional cables.



NOTE
When connecting the cable, the power cords of both the projector and the external equipment should be disconnected from AC outlet.

Connecting to a Computer

Computer (Analog)

Use a VGA cable (option) or a DVI-VGA cable (commercially available).

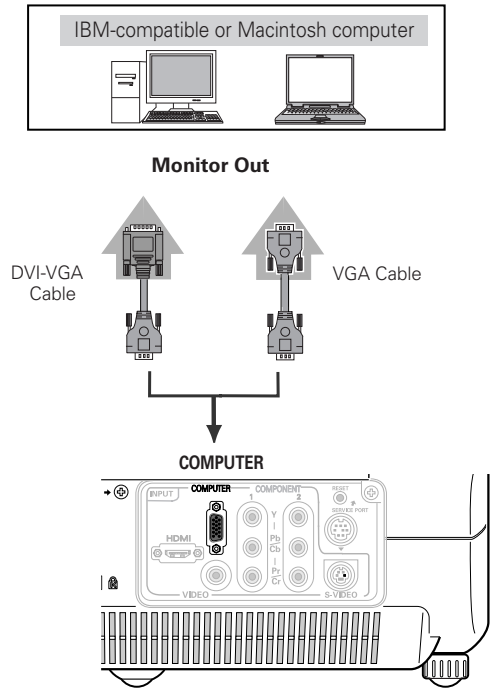

NOTE

- See page 59 for ordering optional cables.



NOTE
When connecting the cable, the power cords of both the projector and the external equipment should be disconnected from AC outlet.

Basic Operation

Turning On the Projector

- 1 Complete peripheral connections (with a computer, VCR, etc.) before turning on the projector.
- 2 Connect the projector's AC power cord into an AC outlet and open the front cover. Turn the Main On / Off switch on, and the POWER indicator flashes red in a moment and turns on red. (If the front cover is being closed, the POWER indicator light orange.)
- 3 Press the POWER ON-OFF button on the top control or on the remote control. The POWER indicator turns green, and the cooling fans start to operate. The preparation display appears on the screen and the count down starts. (A captured image can be used as the preparation display. See "Capture" on page 42.)
- 4 After the count-down, the input source that was selected last and the Lamp mode status icon appear on the screen.

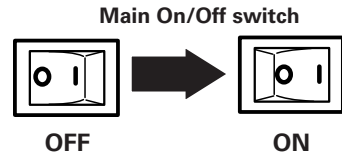
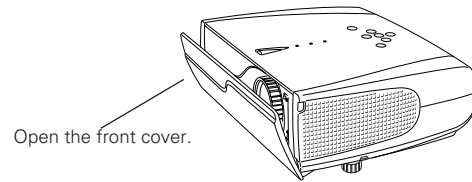

Selected Input Source and Lamp Mode

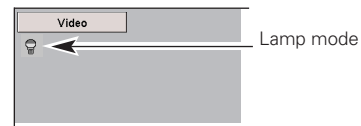

(See page 29, 39 for Lamp mode.)

Turning Off the Projector

- 1 Press the POWER ON-OFF button on the top control or on the remote control, and a message "Power off?" appears on the screen. The message is not displayed and the projector is turned off when the Power off confirmation function is off. (See the Setting Menu on page 43.)
- 2 Press the POWER ON-OFF button again to turn off the projector. The POWER indicator starts to flash red, and it continues while the cooling fans are operating (for about 60 seconds).
- 3 When the projector has cooled down enough to be turned on again, the POWER indicator lights red. Then you can turn the Main On/Off switch off and disconnect the AC power cord.

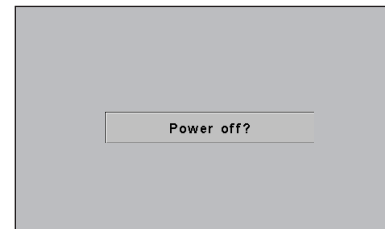

The message disappears after 4 seconds.



TO MAINTAIN THE LIFE OF LAMP, ONCE YOU TURN PROJECTOR ON, WAIT AT LEAST 5 MINUTES BEFORE TURNING IT OFF.

DO NOT DISCONNECT AC POWER CORD WHILE COOLING FANS ARE RUNNING OR BEFORE POWER INDICATOR LIGHTS RED. OTHERWISE IT WILL RESULT IN SHORTENING LAMP LIFE.

NOTE

- When the front cover is closed during operation, the projector is automatically turned off in 5 seconds for safety. Be sure to turn off the projector by pressing the POWER ON-OFF button on the top control or on the remote control after use.
- The projector cannot be turned on during the cooling period with the POWER indicator flashing red. You can turn it on again after the POWER indicator lights red.
- Do not use the projector for more than 24 hours continuously. Turn off the projector at least once in 24 hours and give it a rest. Continuous use may result in shortening the lamp lifetime.
- This projector monitors internal temperature and automatically controls the running speed of the cooling fans.
- If the WARNING indicator flashes or lights red, see "Warning Indicator" on page 45.

Basic Operation

Zoom Adjustment

Move the Zoom Lever to zoom in and out.

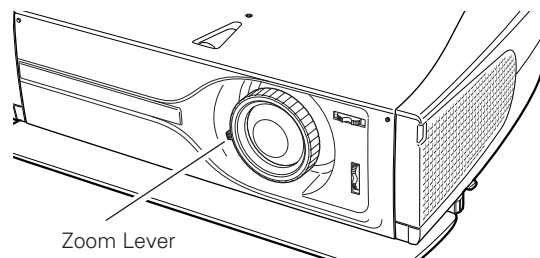

Focus Adjustment

Rotate the Focus Ring to adjust the projected picture focus.

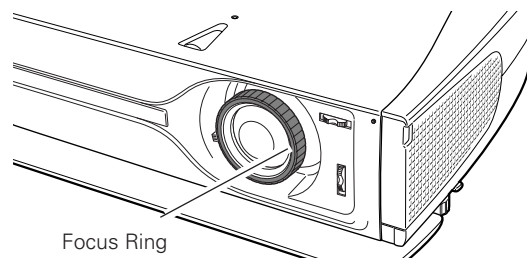

Keystone Adjustment

If a projected picture has keystone distortion, correct the image with KEYSTONE adjustment.

- 1 Press the KEYSTONE ▲/▼ button on the remote control or select the Keystone in the Setting Menu (p41). The Keystone dialog box appears.
- 2 Correct keystone distortion by pressing the KEYSTONE ▲/▼ button or the Point Up/Down button. Press the KEYSTONE ▲ button or the Point Up button to reduce the upper part of image, and press the KEYSTONE ▼ button or the Point Down button to reduce the lower part.

Reduce the upper width with the KEYSTONE ▲ button or the Point Up button.

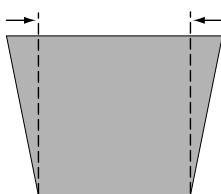

Reduce the lower width with the KEYSTONE ▼ button or the Point Down button.

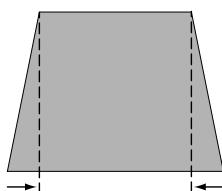

- The arrows are white when there is no correction.
- The arrow disappears at the maximum correction.
- The direction of the arrow being corrected turns purple.

My Picture Function

Press the MY PICTURE (MY-P) button on the remote control to display a captured image. To restore to normal, press the MY PICTURE (MY-P) button again or press any other button.

No Show Function

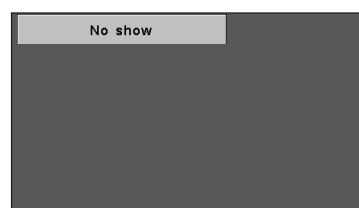

Press the NO SHOW button on the remote control to black out the image. To restore to normal, press the NO SHOW button again or press any other button.



The message disappears after 4 seconds.

On-Screen Menu

You can control and adjust this projector through the On-Screen Menu. Refer to the following pages to operate each adjustment on the On-Screen Menu.

- 1 Press the MENU button on the top control or on the remote control to display the On-Screen Menu (Main Menu).
- 2 Select a menu from the main menu by pressing the Point Up/Down button, and press the Point Right button to enter the sub-menu. (The selected icon turns yellow.)
- 3 Select an item by pressing the Point Up/Down button, and activate the item that you have selected with the  (SELECT),  (Point Left), or  (Point Right) button.
- 4 When using the top control, press the MENU button to close the On-Screen Menu.

When using the remote control, both main menu and sub-menu can be closed by pressing the MENU button. Pressing the CANCEL button once, then you will go back to the previous screen. Or press CANCEL button twice, the On-Screen Menu will be closed.

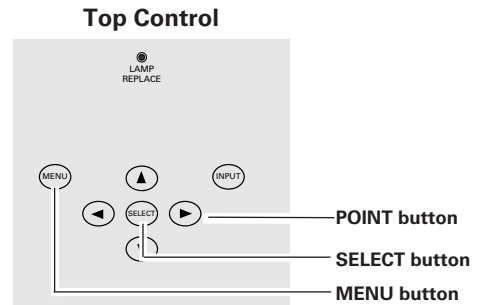
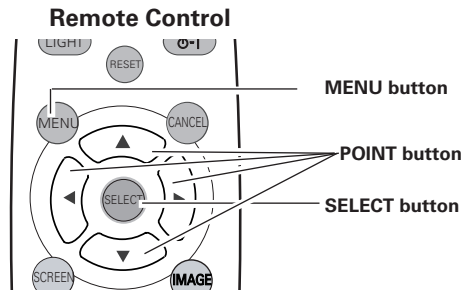

On-Screen Menu (Main Menu)

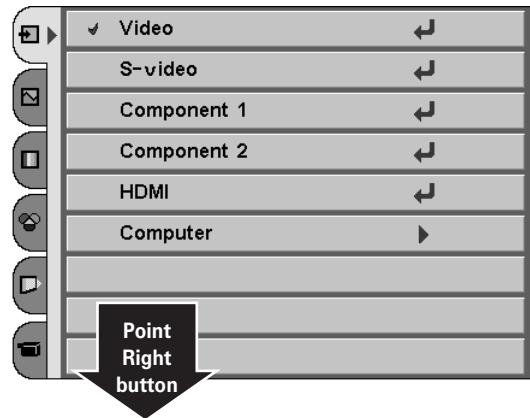



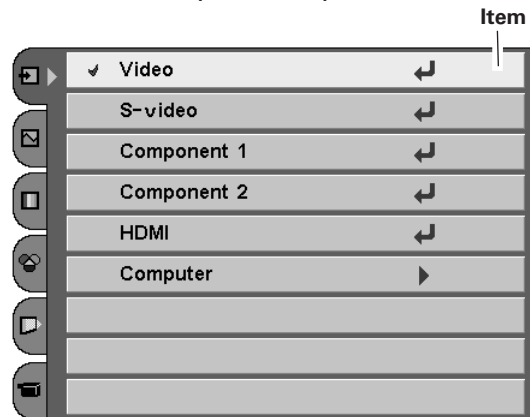



On-Screen Menu (Sub-Menu)









Menus

VIDEO MENUS

	Input Menu: selects input source. (p24-25)
	AV System Menu: selects video system from AUTO, PAL, SECAM, NTSC, NTSC4.43, PAL-M, PAL-N, 1080i, 1035i, 720p, 575p, 480p, 575i, 480i. (p26)
	Image Select Menu: selects image level from Creative cinema, Pure cinema, Natural, Video, Dynamic, Powerful, Graphic, User Image 1 ~ 4. (p27)
	Image Adjust Menu: adjusts Contrast, Brightness, Color, Tint, Color temp., White balance (R/G/B), Sharpness, Gamma, Progressive, Film, Lamp mode, Advanced menu, Reset, Store. (p28, 29)
	Screen Menu: sets the screen size from Full, Full through, Zoom, Caption in 1, Caption in 2, Normal, Normal through, Natural wide 1, Natural wide 2. (p30,31)
	Setting Menu: changes various settings; Language, Keystone, Blue back, Display, Background color, Menu position, Advanced menu, Logo, Capture, Mounting, Rear, Power management, Power off confirmation, Remote control, Lamp counter reset, Factory default, Cleaning, Panel adjustment. (p41-44)

COMPUTER MENUS

	Input Menu: selects input source. (p32)
	PC System Menu: selects computer system. (p33)
	PC Adjust Menu: selects Auto PC adj., Fine sync, Total dots, Horizontal, Vertical, Current mode, Clamp, Display area, Display area H, Display area V, Reset, Mode free, Store. (p34-36)
	Image Select Menu: selects image level from Creative cinema, Pure cinema, Natural, Video, Dynamic, Powerful, Graphic, User Image 1 ~ 4. (p37)
	Image Adjust Menu: adjusts Contrast, Brightness, Color temp., White balance (R/G/B), Sharpness, Gamma, Lamp mode, Advanced menu, Reset, Store. (p38,39)
	Screen Menu: sets the size from Normal, Full, True, Digital zoom. (p40)
	Setting Menu: changes various settings; Language, Keystone, Blue back, Display, Background color, Menu position, Advanced menu, Logo, Capture, Mounting, Rear, Power management, Power off confirmation, Remote control, Lamp counter reset, Factory default, Cleaning, Panel adjustment. (p41-44)

Video Input

Input Source Selection (Video, S-Video, Component1/2, HDMI)

Direct Operation

Choose Input source by pressing the INPUT button on the top control or INPUT buttons on the remote control.

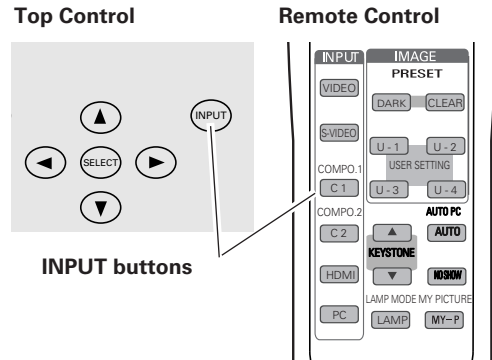

INPUT buttons

Press the VIDEO, S-VIDEO, COMPO.1 COMPO.2 or HDMI button on the remote control according to video input .

- VIDEO** When video input signal is connected to the VIDEO jack, select Video.
- S-VIDEO** When video input signal is connected to the S-VIDEO jack, select S-video.
- COMPO. 1/2** When video input signal is connected to the Y-Pb/Cb-Pr/Cr jacks, select COMPO.
- HDMI** When video input signal is connected to the HDMI terminal, select HDMI.

Remote Control

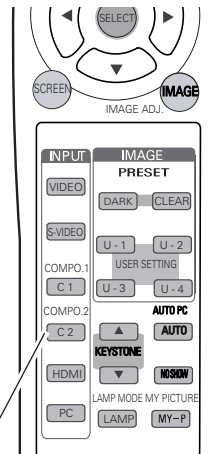

INPUT buttons: VIDEO / S-VIDEO / COMPO.1 / COMPO. 2 /HDMI

Menu Operation

- 1** Select the Input Source with the Point Up/Down button, and then press the Point Right button to enter the sub-menu.
- 2** Select Input source with the Point Up/Down button and then press SELECT button.

Video When video input signal is connected to the VIDEO jack, select Video.

S-Video When video input signal is connected to the S-VIDEO jack, select S-video.

COMPONENT 1/2 When video input signal is connected to the Y-Pb/Cb-Pr/Cr jacks, select Component 1 / 2.

HDMI When video input signal is connected to the HDMI terminal, select HDMI.

Input Source

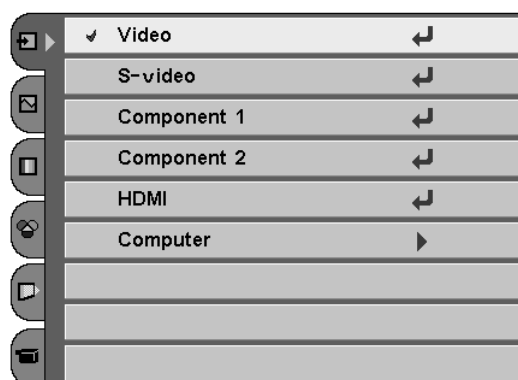
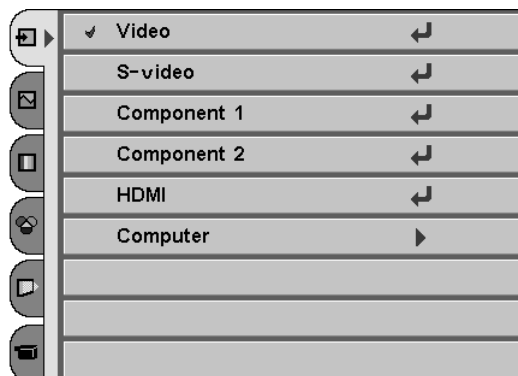

Video System Selection

- 1 Select the AV System Menu with the Point Up/Down button, and then press the Point Right button to enter the sub-menu.
- 2 Choose the system that you want to select with the Point Up/Down button and then press the SELECT button.

Video or S-Video

Auto

The projector automatically detects incoming video system, and adjusts itself to optimize its performance.
When Video System is PAL-M or PAL-N, select system manually.

PAL / SECAM / NTSC / NTSC4.43 / PAL-M / PAL-N

If the projector cannot reproduce proper video image, it is necessary to select a specific broadcast signal format among PAL, SECAM, NTSC, NTSC 4.43, PAL-M, and PAL-N.

Component

Auto

The projector automatically detects incoming video signal, and adjusts itself to optimize its performance.

Component Video Signal Format

If the projector cannot reproduce proper video image, it is necessary to select a specific component video signal format among 480i, 575i, 480p, 575p, 720p, 1035i, and 1080i.

HDMI

Selected system

The projector automatically detects incoming video signal, and adjusts itself to optimize its performance.

If the output signal of the video equipment and the input signal of the projector do not match, you might not get the image with the best quality.

If the black part of the picture appears unclear (too dark or too light), try to select the input signal with "HDMI setup" in setting menu on page 43.

AV System Menu (Video or S-Video)

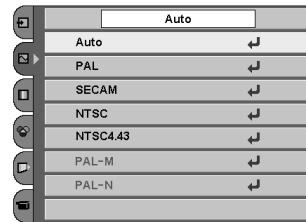
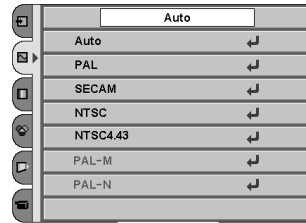

AV System Menu (Component)

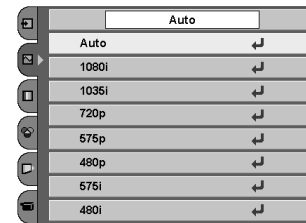
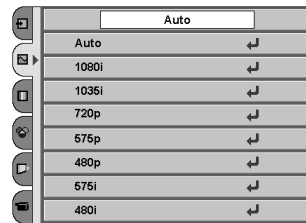

AV System Menu (HDMI)

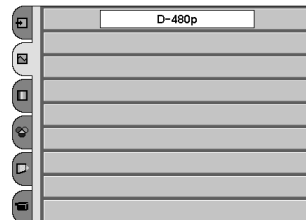

Image Level Selection

Direct Operation

Select an image level among Creative cinema, Pure cinema, Natural, Video, Dynamic, Powerful, Graphic, User Image 1 ~ 4 by pressing the IMAGE buttons (CLEAR, DARK, and U-1-4 buttons) on the remote control. Each time you press the DARK button, Creative cinema, Pure cinema, Natural or Video can be selected. These levels are suitable for a dark room. Also, each time you press the CLEAR button, Dynamic, Powerful or Graphic can be selected. These levels are suitable for a bright room.

Menu Operation

- 1 Select the Image Select Menu with the Point Up/Down button, and then press the Point Right button to enter the sub-menu.
- 2 Choose the level that you want to select with the Point Up/Down button and then press the SELECT button.

Remote Control

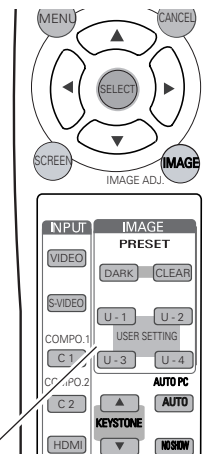

IMAGE buttons



Creative cinema

To enjoy contrasting 3D images in a dark room.



Pure cinema

To enjoy images with quiet tone of colors without excess gradation in a dark room.



Natural

To enjoy faithfully reproduced images without any control by the projector. Suitable for a dark room.



Video

To enjoy sports or dramas from TV with contrasting clear images. Suitable for a dark room.



Dynamic

To enjoy contrasting images in a bright room.



Powerful

To enjoy more contrasting powerful images in a bright room.



Graphic

To enjoy graphic images such as game or PC screen in a bright room.



User image 1~4

User preset images in the Image Adjust Menu (p28, 29)

Image Select Menu

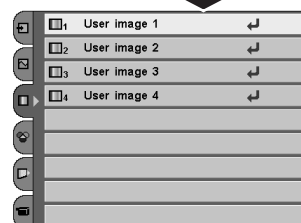
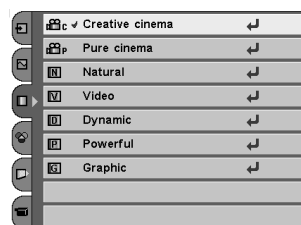
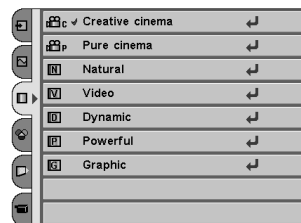

This arrow indicates that there are other items. Select this item and press the Point Down button to go to the next item.

Image Level Adjustment

- 1 Select the Image Adjust Menu with the Point Up/Down button, and then press the Point Right button to enter the sub-menu.
- 2 Select an item with the Point Up/Down button and press the Point Left/Right button to adjust the item.

Contrast

Press the Point Left button to decrease contrast and the Point Right button to increase contrast. (From -31 to +31)

Brightness

Press the Point Left button to adjust image darker and the Point Right button to adjust image brighter. (From -31 to +31)

Color

Press the Point Left button to lighten color and the Point Right button to deepen color. (From -31 to +31)

Tint

Press the Point Left/Right button to obtain proper color. (From -31 to +31)

Color temp.

Press the Point Left/Right button for Color temperature level that you want to select. (High, Mid, Low1, Low2, Low3)

White balance (Red)

Press the Point Left button to lighten red tone and the Point Right button to deepen red tone. (From -31 to +31)

White balance (Green)

Press the Point Left button to lighten green tone and the Point Right button to deepen green tone. (From -31 to +31)

White balance (Blue)

Press the Point Left button to lighten blue tone and the Point Right button to deepen blue tone. (From -31 to +31)

Sharpness

Press the Point Left button to soften the image and the Point Right button to sharpen the image. (From -7 to +7)

Gamma

Press the Point Left/Right button to obtain better balance of contrast. (From -7 to +7)

NOTE

- Tint cannot be selected when the video system is PAL, SECAM, PAL-M, or PAL-N except for 575i.
- Color and Tint cannot be selected when the input source is HDMI.
- After adjusting any of the White balance Red, Green or Blue, the Color temp. display will change to "User".

Image Adjust Menu



The level being selected



This arrow indicates that there are other items. Select this item and press the Point Down button to go to the next item.



Press the SELECT button or Point Up/Down button to adjust the next item. Press the MENU button to return to the previous On-Screen Menu and store the adjusted value.

Go on to the next page...

Direct Operation with Remote control

You can adjust the items in the Image Level Adjustment menu with pressing the IMAGE ADJ. button on the remote control. Press Point Left/Right button to adjust each item. Press Up/Down button to get to the next item.

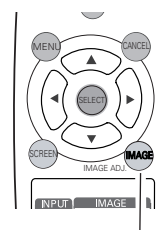

IMAGE ADJ. button

Progressive

Interface video signal can be converted to a progressive signal.

Off Not activated.

L1 Select "L1" for an active picture.

L2 Select "L2" for a still picture.

Film

When this function is on, it detects proper interleaving of 3-2 and 2-2 pull down for film-base sources and produces a suitable image for the input source. (This function is available only when selecting L1 or L2 on Progressive for NTSC(480i), PAL, SECAM(575i).)

Lamp mode

This function allows you to change brightness of the screen.

Bright mode Normal brightness

React image mode 1 ... The controlled brightness according with input signal

React image mode 2 ... Less bright but quieter than React image mode 1.

Theater black mode ... Lowers brightness and reduces the lamp power consumption.

Advanced menu

This function can be selected only when Advanced menu in the Setting is On . You can adjust following items through this function.

Iris Press the Point Left button to adjust Iris.It works only to stop down from zero.

Gain R/G/B Adjusts red, green and blue to select contrast of colors you like.

Offset R/G/B Adjusts red, green and blue to select brightness of the colors you like.

Gamma R/G/B Adjusts red, green and blue to select neutral colors you like.

Auto black stretch When this function is On, the black color in the bright image is shown up.

Contrast enhancement ... Adjusts the contrast of colors in the brighter image. You can select from Off/L1/L2/L3. L3 is the most contrasty.

Transient improvement ... Adjusts the sharpness of the outline. You can select from Off/L1/L2/L3. L3 is the sharpest.

Overscan Adjusts overscanned area. It works only to decrease the overscanned portion of the screen from zero.

Reset

Resets adjustments to their factory default settings.

Store

To store the adjustment data, select Store and press the Point Right button. The Image Level Menu will appear. Choose one of 4 image levels with the Point Up/Down button and press the SELECT button. A confirmation box will appear and select [Yes].

NOTE

- Progressive cannot be selected when 480p, 575p, 720p is selected.
- Auto black stretch and Contrast enhancement and Transient improvement in the Advanced menu cannot be selected when the input source is HDMI.
- Overscan cannot be selected when Full through and Normal through are selected in the Screen Size Adjustment menu.

This arrow indicates that there are previous items. Select this item and press the Point Up button to go to the previous item.



Press the Point Right button at this icon to store the value.

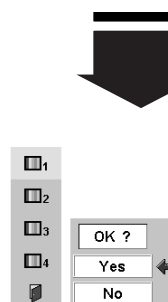

The Image Level Menu will appear. Choose one of 4 image levels with the Point Up/Down button and press the SELECT button. A confirmation box will appear and select [Yes].

Direct Operation with Remote control

Pressing the LAMP button on the remote control, you can select the lamp mode.

Pressing the RESET button on the remote control, adjustments will reset to their factory settings.

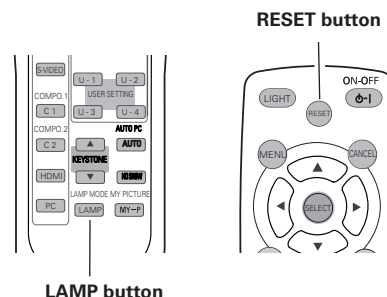

LAMP button

RESET button

Screen Size Adjustment

This projector has a useful function to resize a projected screen.

- 1 Select the Screen Menu with the Point Up/Down button, and then press the Point Right button to enter the sub-menu.
- 2 Select an item with the Point Up/Down button and press the Point Left/Right button to set the screen size.

Full

Provides an image to fit the width of the screen by expanding the width of the image uniformly. This function can be used to project a squeezed video signal at a wide video aspect ratio of 16 : 9. When your video equipment (such as DVD) has 16 : 9 output mode, select 16 : 9 and select Full in this Screen Menu to provide better quality.

Full through

Expands the width of an image and projects it in the center at a wide screen ratio of 16 : 9. (You can enjoy a high-quality image though the projected image is small.)

Zoom

Provides an image to fit the screen size (16 : 9 aspect ratio) by expanding the width and height of the image uniformly. This function can be used to project a letter box mode picture (4 : 3 aspect picture with black bar on the top and bottom edges) at a wide video aspect ratio of 16 : 9.

1 Caption in 1

Provides an image including a caption to fit the screen size (16 : 9 aspect ratio) by expanding the height of the image uniformly.

2 Caption in 2

Provides an compressed image including captions to fit the screen size(16:9 aspect ratio). This function is useful for the caption with number of lines.

Normal

Provides an image at a normal video aspect ratio of 4 : 3.

NOTE

- When Full through and Normal through are selected, overscan cannot be selected in the Image Level Adjustment menu.

Screen Menu



Full

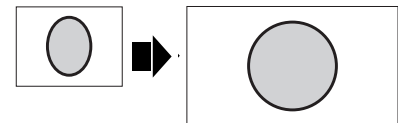

Full through

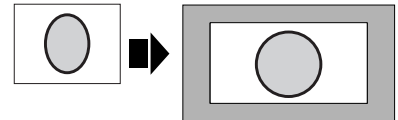

Zoom

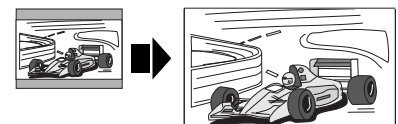

Caption in 1

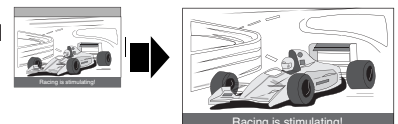

Caption in 2

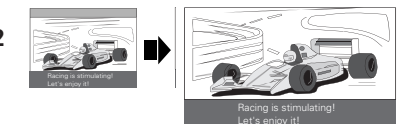

Normal

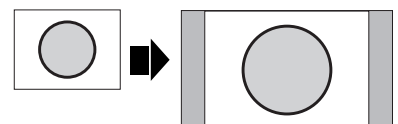



Normal through

Provides an image with no modification. (You can enjoy a high-quality image though the projected image is small.)



Natural wide 1

Modifies an image of 4 : 3 aspect ratio to fit the screen size (16 : 9 aspect ratio). It expands the width and height of the image and makes it look natural.



Natural wide 2

When the signal is 16:9, modifies an image of 4 : 3 aspect ratio to fit the screen size (16 : 9 aspect ratio). It expands the width and height of the image and makes it look natural.

Normal through

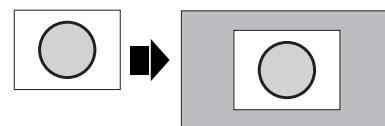

Natural wide 1

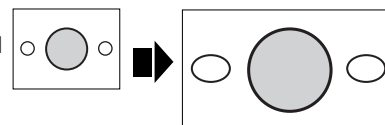

Natural wide 2

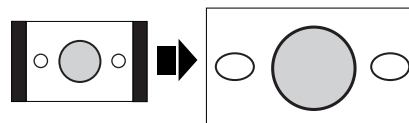

Direct Operation with Remote control

Pressing the SCREEN button on the remote control, you can resize the projected screen.

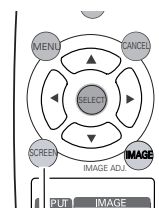

SCREEN button

NOTE

- When "720p", "1035i", or "1080i" is selected in the AV System Menu, Screen menu cannot be selected except for Full and Natural wide 2.(p26).
- When you do not select any signal format and enter the Screen menu, Full is selected automatically, and the other items cannot be selected wherever the check mark is.

Computer Input

Input Source Selection

Direct Operation

Choose INPUT source by pressing the INPUT button on the top control or PC button on the remote control.

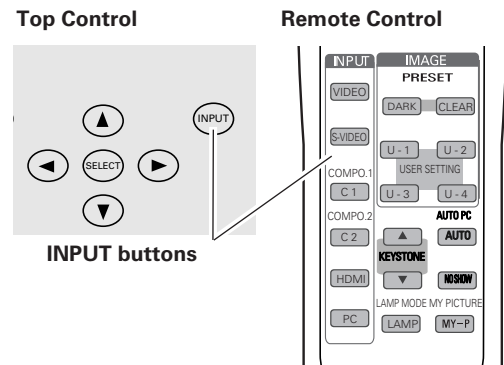

Menu Operation

- 1 Select the Input Source Selection Menu with the Point Up/Down button, and then press the Point Right button to enter the sub-menu.
- 2 Select Computer with Point UP/DOWN button and then press the Point Right button. The Source Select Menu will appear.
- 3 Move the pointer to the source that you want to select and then press the SELECT button.

RGB (Analog) When the input source is analog coming from a computer connected to the COMPUTER terminal, select RGB (Analog).

RGB (Scart) When the input terminal is Scart with a DVD player connected to the COMPUTER terminal, select RGB (Scart).

Input Menu

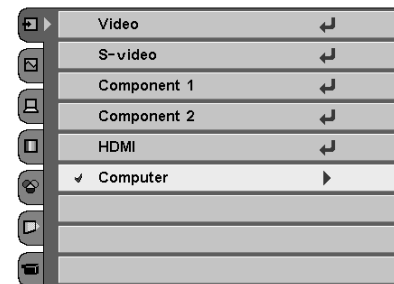
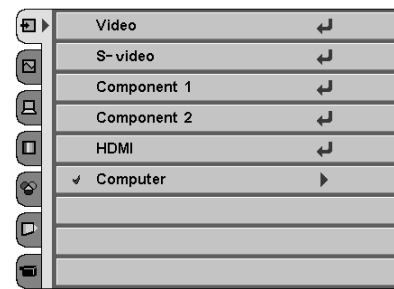

Source Selection Menu

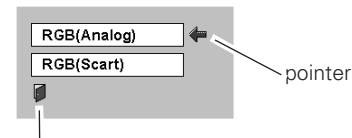

Closes the source selection menu.

Computer System Selection

This projector can detect most of the current computer systems with the Multi-scan system and the Auto PC adjustment function provided in the projector. When selecting computer input, the projector automatically displays the most proper image for the input signal. One of the following four displays appears on the system menu icon. If the projector does not tune the input signal and the projected image is not displayed properly, or when you wish to adjust it manually, perform manual adjustment as described on page 35 and 36.

Auto When the projector cannot recognize the connected signal as PC system provided in this projector, the Auto PC adjustment function operates to adjust the projector and the message "Auto" is displayed in the PC System Menu icon. When the image is not provided properly, manual adjustment is required. (p35, 36)

---- There is no signal input from the connected computer. Check the connection of the computer and see if the projector is set correctly. (See "Troubleshooting" on page 52.)

Mode 1 User preset adjustment in Computer Adjustment. Adjustment data can be stored in Mode 1 - 5. (p35, 36)

SVGA 1 Computer systems provided in the projector. The projector chooses a proper system and displays it.

*Mode 1 and SVGA 1 are examples.

PC System Menu

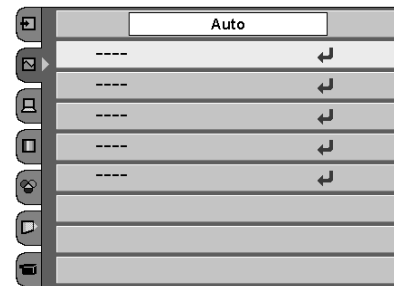

Menu Operation

PC system can also be selected manually if some PC systems appear on the On-Screen Menu.

- 1 Select the PC System Menu with the Point Up/Down button, and then press the Point Right button to enter the sub-menu.
- 2 Choose the system that you want to select with the Point Up/Down button and then press the SELECT button.

PC System Menu

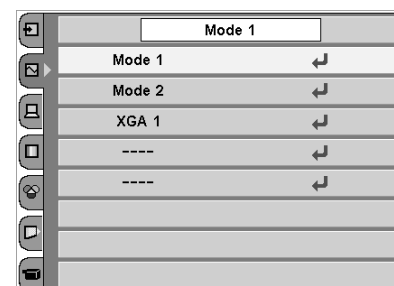
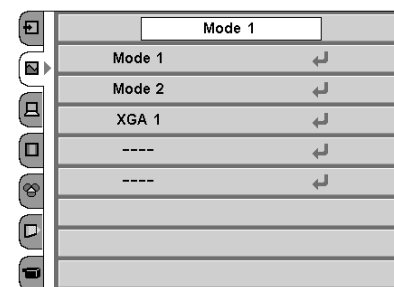

Computer Adjustment (Auto)

The Auto PC adjustment function is provided to automatically adjust Fine sync, Total dots, Horizontal, and Vertical to conform to your computer. This function can be operated as follows.

- 1 Select the PC Adjust Menu with the Point Up/Down button, and then press the Point Right button to enter the sub-menu.
- 2 Choose the AUTO PC adj. item and then press the SELECT button.

Auto PC adj.

Automatically adjusts Fine sync, Total dots, Horizontal, and Vertical for the input signal from your computer.

To store adjustment data

Adjustment parameters from Auto PC adjustment can be memorized in this projector. Once parameters are memorized, the setting can be done just by selecting Mode in the PC System Menu (p33). See "Store" on page 36.

NOTE

- The Auto PC adjust cannot be operated when 480i", "575i", "480p", "575p", "720p(HDTV)", "1035i(HDTV)", or "1080i"(HDTV) is selected in the PC System Menu.

PC Adjust Menu

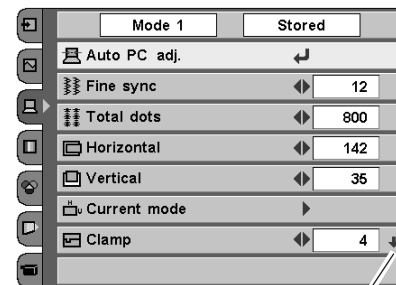
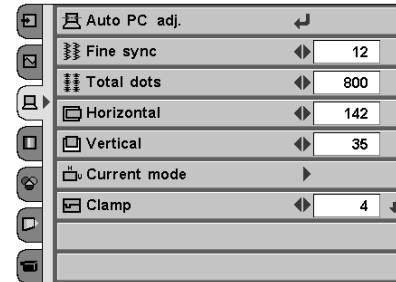

This arrow indicates that there are other items. Select this item and press the Point Down button to go to the next item.

Computer Adjustment (Manual)

Some computers employ special signal formats which may not be tuned by Multi-scan system of this projector. This projector has Manual PC Adjustment to enable you to precisely adjust several parameters to match those signal formats. The projector has 5 independent memory areas to memorize those parameters manually adjusted. This enables you to recall the setting for a specific computer whenever you use it.

- 1 Select the PC Adjust Menu with the Point Up/Down button, and then press the Point Right button to enter the sub-menu.
- 2 Select an item with the Point Up/Down button and press the Point Left/Right button to adjust each item.

Fine sync

Adjusts an image as necessary to eliminate flicker from the display. Press the Point Left/Right button to adjust value. (From 0 to 31)

Total dots

Adjusts the number of total dots in one horizontal period. Press the Point Left/Right button and adjust number to match your PC image.

Horizontal

Adjusts horizontal picture position. Press the Point Left/Right button to adjust the position.

Vertical

Adjusts vertical picture position. Press the Point Left/Right button to adjust the position.

Current mode

Press the Point Right button to show the information of the connected computer.

Clamp

Adjusts clamp level. When the image has dark bars, try this adjustment.

PC Adjust Menu

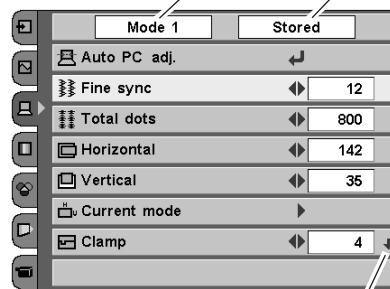
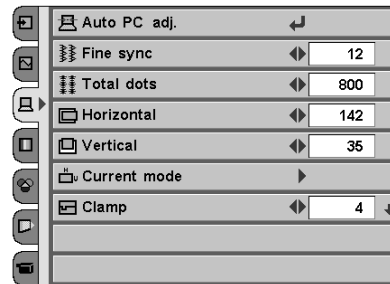

Shows status (Stored / Free) of the selected Mode.



This arrow indicates that there are other items. Select this item and press the Point Down button to go to the next item.



Press the SELECT button to adjust the next item. Press the MENU button to return to the previous On-Screen Menu and store the adjusted value.

Go on to the next page...

Display area

Select the resolution at the Display area dialog box.

Display area H

Adjusts the horizontal area displayed by this projector. Press the Point Left/Right button to decrease/increase value.

Display area V

Adjusts the vertical area displayed by this projector. Press the Point Left/Right button to decrease/increase value.

Reset

Resets adjustments to their factory default settings.

Mode free

To clear adjustment data previously set, select Mode free and press the Point Right button. A dialog box will appear and choose one of 5 modes and then press the SELECT button.

Store

To store adjustment data, select Store and press the Point Right button. A dialog box will appear and choose one of 5 modes and then press the SELECT button.



Select Store to store adjustment data.

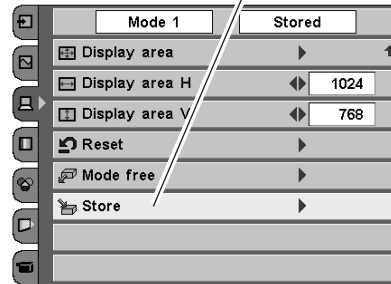

To clear adjustment data

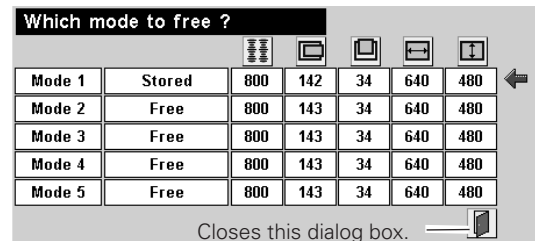

To store adjustment data

This Mode has parameters being stored.

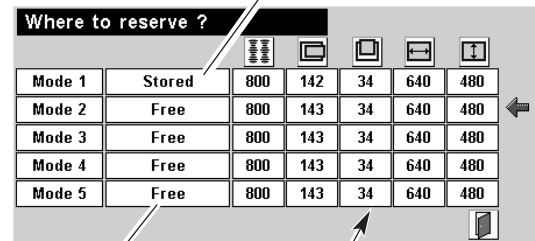

Vacant Mode

Shows values of "Total dots," "Horizontal," "Vertical," "Display area H," and "Display area V."

Direct Operation with Remote control

Pressing the RESET button on the remote control, adjustments will reset to their factory settings.

RESET button

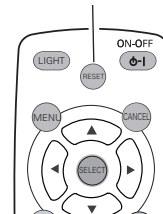

NOTE

- Display area, and Display area (H/V), cannot be selected when "480i", "575i", "480p", "575p", "720p(HDTV)", "1035i(HDTV)", or "1080i"(HDTV) is selected in the PC System Menu (p33).

Image Level Selection

Direct Operation

Select an image level among Creative cinema, Pure cinema, Natural, Video, Dynamic, Powerful, Graphic, User Image 1 ~ 4 by pressing the IMAGE buttons (CLEAR, DARK, and U-1-4 buttons) on the remote control. Each time you press the DARK button, Creative cinema, Pure cinema, Natural or Video can be selected. These levels are suitable for a dark room. Also, each time you press the CLEAR button, Dynamic, Powerful or Graphic can be selected. These levels are suitable for a bright room.

Menu Operation

- 1 Select the Image Select Menu with the Point Up/Down button, and then press the Point Right button to enter the sub-menu.
- 2 Choose the level that you want to select with the Point Up/Down button and then press the SELECT button.

Creative cinema

To enjoy contrasting 3D images in a dark room.

Pure cinema

To enjoy images with quiet tone of colors without excess gradation in a dark room.

Natural

To enjoy faithfully reproduced images without any control by the projector. Suitable for a dark room.

Video

To enjoy sports or dramas from TV with contrasting clear images. Suitable for a dark room.

Dynamic

To enjoy contrasting images in a bright room.

Powerful

To enjoy more contrasting powerful images in a bright room.

Graphic

To enjoy graphic images such as game or PC screen in a bright room.

User image 1~4

User preset images in the Image Adjust Menu (p38, 39)

Remote Control

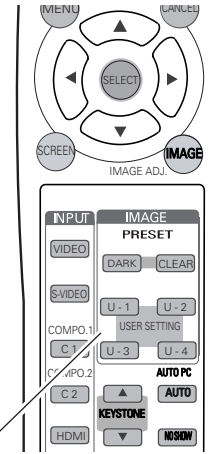

IMAGE buttons

Image Select Menu

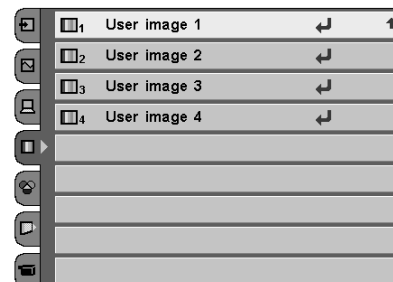
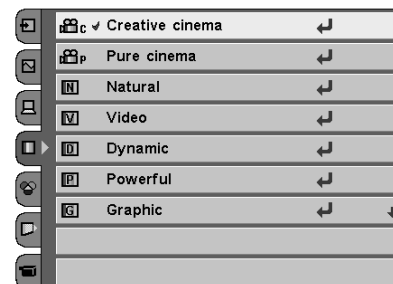
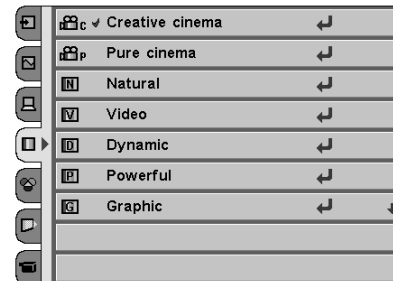

Image Level Adjustment

1 Select the Image Adjust Menu with the Point Up/Down button, and then press the Point Right button to enter the sub-menu.

2 Select an item with the Point Up/Down button and press the Point Left/Right button to adjust the item.

Contrast

Press the Point Left button to decrease contrast and the Point Right button to increase contrast. (From -31 to +31)

Brightness

Press the Point Left button to adjust image darker and the Point Right button to adjust image brighter. (From -31 to +31)

Color temp.

Press the Point Left/Right button for Color temperature level that you want to select. (High, Mid, Low1, Low2, Low3)

White balance (Red)

Press the Point Left button to lighten red tone and the Point Right button to deepen red tone. (From -31 to +31)

White balance (Green)

Press the Point Left button to lighten green tone and the Point Right button to deepen green tone. (From -31 to +31)

White balance (Blue)

Press the Point Left button to lighten blue tone and the Point Right button to deepen blue tone. (From -31 to +31)

Sharpness

Press the Point Left button to soften the image and the Point Right button to sharpen the image. (From -7 to +7)

Gamma

Press the Point Left/Right button to obtain better balance of contrast. (From -7 to +7)

Direct Operation with Remote control

You can adjust the items in the Image Level Adjustment menu with pressing the IMAGE ADJ. button on the remote control. Press Point Left/Right button to adjust each item. Press Up/Down button to get to the next item.

NOTE

- After adjusting any of the White balance Red, Green or Blue, the Color temp. will change to "User".

Image Adjust Menu

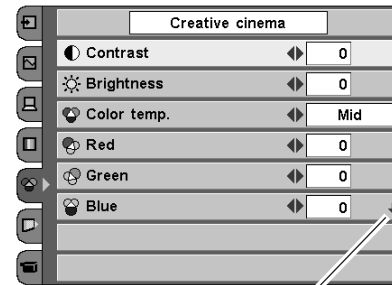

This arrow indicates that there are other item menus.



Press the SELECT button or Point Up/Down button to adjust the next item. Press the MENU button to return to the previous On-Screen Menu and store the adjusted value. (See p38)

Go on to the next page...

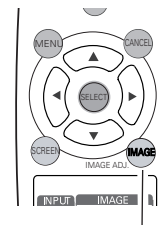





IMAGE ADJ. button

Lamp mode

This function allows you to change brightness of the screen.

-  Bright mode Normal brightness
-  React image mode 1 . . . The controlled brightness according with input signal
-  React image mode 2 . . . Less bright but quieter than React image mode 1.
-  Theater black mode . . . Lowers brightness and reduces the lamp power consumption.

Advanced Menu

This function can be selected only when Advanced menu in the Setting is On . You can adjust following items through this function.

- Iris Press the Point Left button to adjust Iris.It works only to stop down from zero.
- Gain R/G/B Adjusts red, green and blue to select contrast of colors you like.
- Offset R/G/B Adjusts red, green and blue to select brightness of the colors you like.
- Gamma R/G/B Adjusts red, green and blue to select neutral colors you like.

Reset

Resets adjustments to their factory default settings.

Store

To store the adjustment data, select Store and press the Point Right button. The Image Level Menu will appear. Choose one of 4 image levels with the Point Up/Down button and press the SELECT button. A confirmation box will appear and select [Yes].

Direct Operation with Remote control

Pressing the LAMP button on the remote control, you can select the lamp mode.

Pressing the RESET button on the remote control, adjustments will reset to their factory settings.

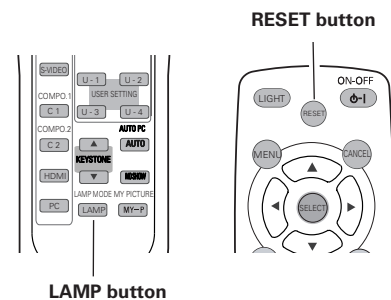
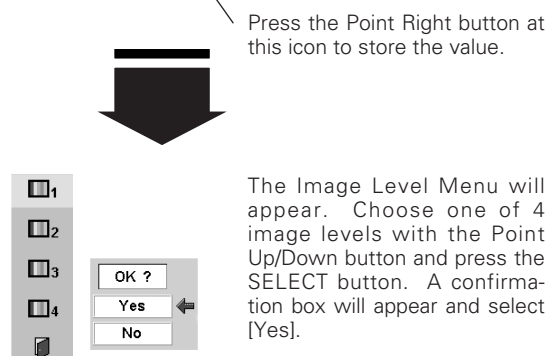
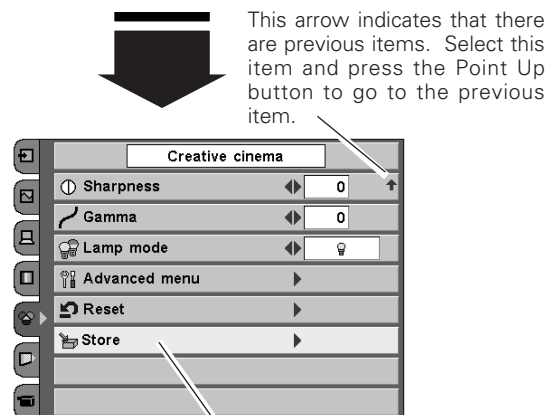

Screen Size Adjustment

This projector has a useful function to resize a projected screen.

- 1 Select the Screen Menu with the Point Up/Down button, and then press the Point Right button to enter the sub-menu.
- 2 Select an item with the Point Up/Down button and press the Point Left/Right button to set the screen size.

Normal

Provides image to fit screen size.

Full

Provides an image to fit the horizontal size of the screen.

True

Provides image in its original size. When the original image size is larger than the screen size (1280 x 720), this projector enters "D. zoom" mode automatically. "D. zoom" mode will be canceled after 10 seconds stop panning.

Digital zoom

When Digital zoom is selected, the On-Screen Menu disappears and the message "D.Zoom" is displayed. Press the SELECT button to expand the image. And press the POINT UP/DOWN/LEFT/RIGHT button(s) to pan the image. The panning function can work only when the original image is larger than screen size (1280 x 720).

Screen Menu

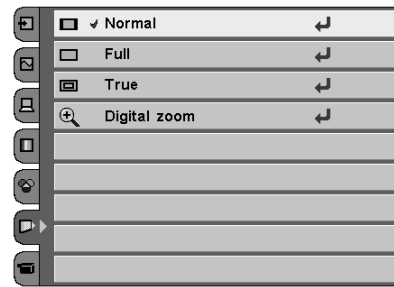
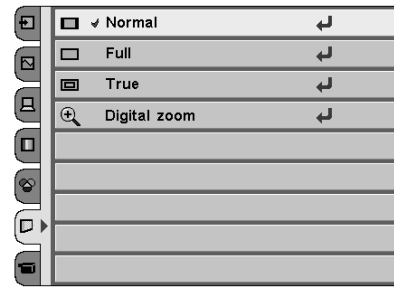

Direct Operation with Remote control

Pressing the SCREEN button on the remote control, you can resize the projected screen.

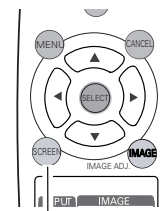

SCREEN button

NOTE

- This Screen Menu cannot be operated when "720p (HDTV)", "1035i (HDTV)", or "1080i (HDTV)" is selected in the PC System Menu (p33).
- Digital. zoom cannot be selected when "480i", "575i", "480p", or "575p" is selected in the PC System Menu (p33).
- Digital zoom can not be selected when True is selected.
- While selecting Digital zoom, press CANCEL button then the message "D. Zoom" disappear with keeping the screen size you have adjusted.
- While selecting Digital zoom, press RESET button then the adjustment goes back to the factory default setting.
- This projector cannot display any resolution higher than 1280 X 720. If your computer's screen resolution is higher than 1280 X 720, reset the resolution to the lower before connecting to the projector.
- The image data in other than the resolution (1280 x 720) is modified to fit the screen size in initial mode.
- The panning function may not operate properly if the computer system prepared in the PC Adjust Menu is used.

Setting

Setting

- 1 Select the Setting Menu with the Point Up/Down button, and then press the Point Right button to enter the sub-menu.
- 2 Select an item with the Point Up/Down button to set various settings.

Language

The language used in the On-Screen Menu is available in English, German, French, Italian, Spanish, Portuguese, Dutch, Swedish, Russian, Chinese, Korean, or Japanese.

Keystone

When the image is distorted vertically, select the Keystone. The On-Screen Menu disappears and the Keystone dialog box is displayed. Correct keystone distortion by pressing the Point Up/Down button. Refer to Keystone Adjustment on page 21.

Blue back

When this function is "On," the projector produces a blue image while input signal is not detected.





Display

This function decides whether to display On-Screen Displays.

- On shows all the On-Screen Displays.
- Off does not show On-Screen Displays except;
 - On-Screen Menu
 - "Power off?" message
 - "No signal" message
 - "Wait a moment!" message

Background color

This function is used to change the color of background in the On-Screen Menu.

- Default background color
-  **1**Background color is grayish and half transparent.
-  **2**Background color is blackish and half transparent.
-  **3**Background color is transparent.

Menu position

This function is used to change the position of the On-Screen Menu. Move it with the Point Up/Down/Left/Right button and press the SELECT button to set it.

NOTE

- While selecting Keystone, press RESET button then the adjustment goes back to the factory default setting.

Setting Menu (Language)

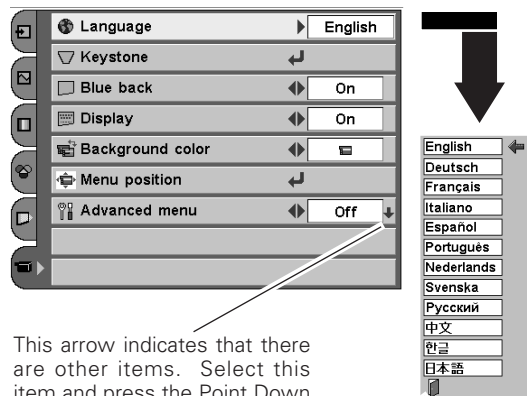
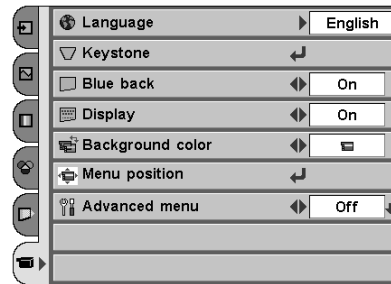

This arrow indicates that there are other items. Select this item and press the Point Down button to go to the next item.

After selecting a language, move the pointer to this icon, and press the SELECT button to activate it.

Menu position

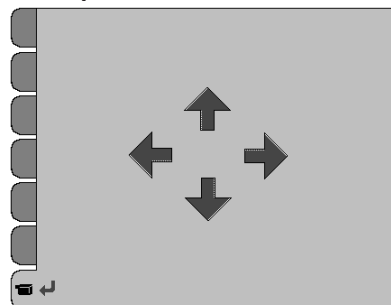

Advanced menu

When this function is On, Advanced menu in Image level adjustment (both Video and computer input) can be selected. See Image level adjustment (p.29,39) for details.

L **Logo**

This function decides what to be displayed when starting up.

- Off count-down only
- Default the factory-set logo
- User the image you captured

Capture

This function is used to capture the image being projected and use it for a starting-up display or interval of presentations. After capturing the projected image, go to the Logo function and set it as "User". Then the captured image will be displayed when turning on the projector next time or pressing the MY PICTURE (MY-P) button on the remote control. (p11)

To capture the image, select [Yes]. To cancel the Capture function, select [No]. To stop capturing in the middle, press CANCEL button.

Mounting

This function is used to select the way of setting the projector.

- Off Cancels the selected way of setting
- Ceiling Used to project the image from a ceiling mounting the projector. The picture is top/bottom and left/right reversed.
- Wall Used to project the image from a wall-hanging projector. The picture is top/bottom reversed.

Rear

When this function is "On," the picture is left/right reversed. This function is used to project the image to a rear projection screen.

Capture

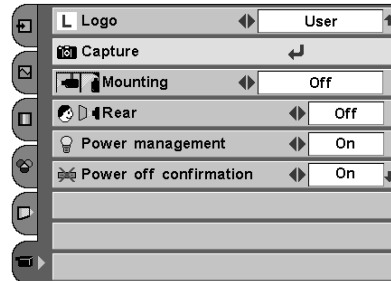

Mounting

Ceiling

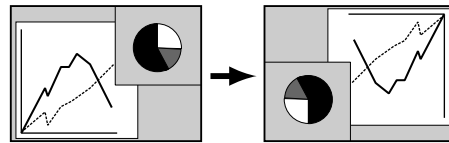

Wall

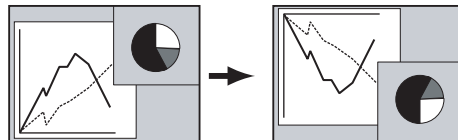

Rear

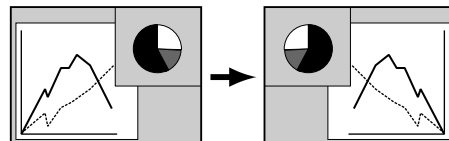

NOTE

- A signal from a computer can be captured up to XGA(1024 x 768). If selecting 1280 x 1024 at Display area in the PC Adjust Menu (p36), then the image cannot be captured.
- A signal from video equipment can be captured except for 720p, 1035i, 1080i.
- When capturing the image that has been adjusted by the Keystone function, the adjustment data is automatically reset and the projector captures an image without keystone adjustment.
- If the Capture function fails to capture an image or cancel to capture in the middle, the On-Screen Menu returns to the Capture item.
- If capturing a signal which is not able to be captured, an exclamation mark appears and the function will not be available.
- When you change the Image Level, the Image Level of MY PICTURE also changes from which it was captured.

Power management

For reducing power consumption as well as maintaining the lamp life, the Power management function turns off the projection lamp when the input signal is interrupted and no button is pressed for 30 seconds or more.

When the input signal is interrupted and no button is pressed for 30 seconds or more, the timer display with the message "No signal" appears on the screen. The count-down starts for 5 minutes.

When the count-down time has elapsed, the lamp will be turned off to cool itself down. The POWER indicator is flashing red during this cooling-off period. The next performance depends on setting as follows.

On ... When the lamp has been fully cooled down, the POWER indicator changes to green flashing. In this condition, the projection lamp will be turned on if the input signal is reconnected or any button on the top control or remote control is pressed.

Off ... The Power management function is canceled.

Power off confirmation

The confirmation dialog box to turn off the projector is displayed with this function ON.

Remote control

This projector has two different remote control codes: Code 1 (initial code) and Code 2. This switching function prevents remote control interference when operating several projectors or video equipment together.

When operating the projector in "Code 1", both the projector and the remote control must be switched to "Code 1".

To change the code of the projector;

Set the remote control code in the Setting Menu to "Code 2".

To change the code of the remote control;

Open the compartment lid on back of the remote control then you will find a white switch. Slide it left or right to change the code of the remote control.

After changing the code, make sure the remote control operates properly.

To return to the initial code (Code 1), repeat the steps above.

HDMI setup

Select L1 or L2 with Point Left/Right button according to the output signal of the video equipment.

L1When the output of the video equipment is set "STANDARD".

L2When the output of the video equipment is set "ENHANCED".

The names of the output setting of the video equipment vary from equipment to equipment. For details, refer to the owner's manual of the video equipment.

NOTE

- When the batteries of the remote control are replaced, the remote control code automatically returns to the initial code (Code 1).

This arrow indicates that there are previous items. Select this item and press the Point Up button to go to the previous item.

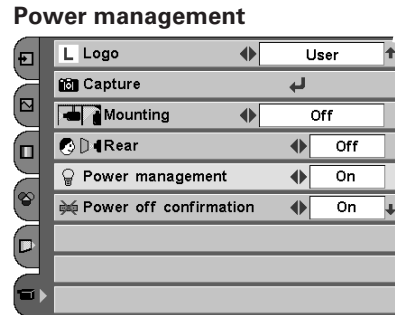

Time left until lamp off

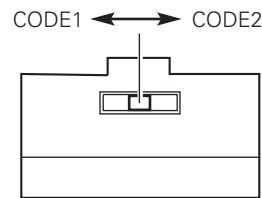

Remote control Code switch

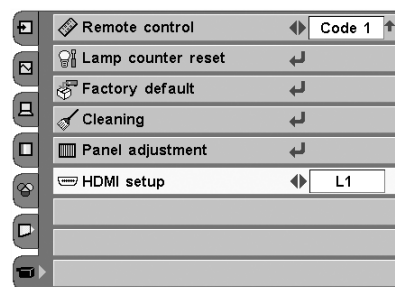

Lamp counter reset

This function is used to reset the lamp replace counter. When replacing the projection lamp, reset the lamp replace counter by using this function. See page 51 for operation.

Factory default

This function returns all setting values except for the lamp counter to the factory default settings.

Cleaning

This function is used to clean inside of the projector. Using blower at the same time is more effective. (See p48)

Press the SELECT button, then the projected image is blacked out temporary whether input source is selected or not. The fan starts to move automatically to help blowing the dust.

To restore to normal, press any other buttons.
To cancel, press any other button during the cleaning operation.

Panel adjustment

This function is used to get the best picture reproduction of each of the R(red), G(green) and B(blue) LCD panels. If proper adjustment is not made, you might get vertical noise lines on the screen.

This function should be made about ten minutes after turning on the projector, with any signals or without a signal.
Darker environment makes your adjustment more accurate.

The Test pattern screens appear in the order of red, green, blue. Adjust each patterns as follows.

1. Adjust Bright dialog to minimize vertical lines in the bright part of the picture.
2. Adjust Dark dialog to minimize vertical lines in the dark part of the picture.
3. Press the Point Up/Down button to get to the next color. Repeat 1 and 2 for each of R,G,B panels until lines of the picture are minimized.
4. Press the Point Up/Down button to get to the Check pattern screen and check adjustment.
5. To close this screen, press MENU.

NOTE

- When Panel adjustment is selected, Power management cannot be selected.

Factory default

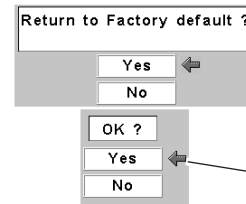
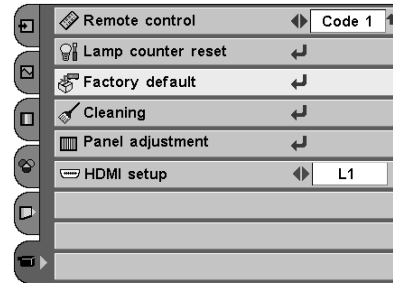

Select Factory default and this box appears. Select [Yes], and the next box appears.

Select [Yes] to activate it.

1. Adjust bright parts with the bright dialog.

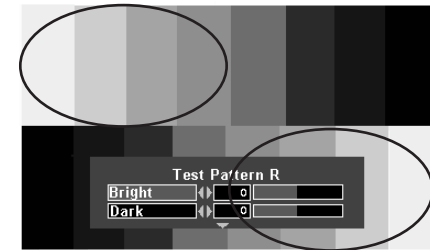

2. Adjust dark parts with the dark dialog.

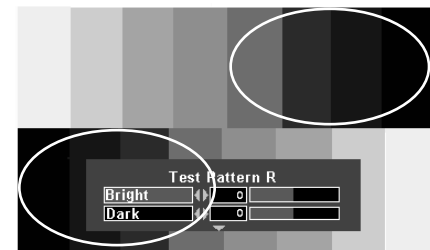

3. Then adjust Test pattern G and Test pattern B in the same way.

4. Check adjustment with Check pattern screen.

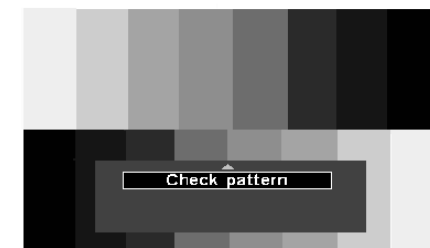

Maintenance and Cleaning

Warning Indicator

The WARNING indicator shows the state of the function which protects the projector. Check the state of the WARNING indicator and the POWER indicator to take proper maintenance.

The projector is shut down and the WARNING indicator is flashing red

When the temperature inside the projector exceeds the normal temperature, the projector is automatically shut down to protect the inside of the projector. The POWER indicator is flashing and the projector is being cooled down. When the temperature inside the projector returns to normal, the POWER indicator lights red and the projector can be turned on.

NOTE

- After the temperature inside the projector returns to normal, the WARNING indicator still continues to flash. When the projector is turned on again, the WARNING indicator stops flashing.

Then check the items below.

- ✓ Did you provide appropriate space for the projector to be ventilated? Check the installing condition to see if ventilation slots are not blocked.
- ✓ Is the projector not installed near the ventilation duct of air-conditioning equipment which may be hot? Install the projector away from the ventilation duct of air-conditioning equipment.
- ✓ Is the air filter clean? Clean the air filter or replace it with a new one.

The projector is shut down and the WARNING indicator lights red

When the projector detects an abnormal condition, it is automatically shut down to protect the inside and the WARNING indicator lights red. In this case, disconnect the AC power cord and reconnect it, and then turn the projector on once again for check. If the projector is turned off again and the WARNING indicator lights red, disconnect the AC power cord and contact the service station for check and repair.



CAUTION

DO NOT LEAVE THE PROJECTOR WITH THE AC POWER CORD CONNECTED UNDER THE ABNORMAL CONDITION. IT MAY RESULT IN FIRE OR ELECTRIC SHOCK.

TOP CONTROL

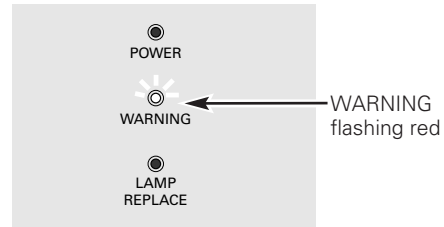

TOP CONTROL

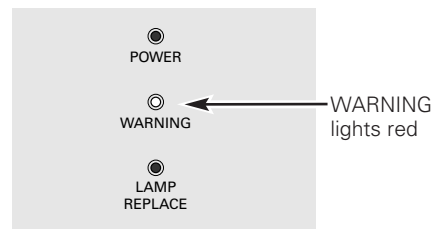

Cleaning the RGB panels

If some dusts attach to optical parts inside the projector, the brightness could decrease or shadows could appear on the screen and image deterioration could result.

This projector equipped with RGB panel cleaning holes on the bottom of the projector to clean the internal parts (such as optical parts) of the projector. When you use the projector continuously for hours or you find shadows of dust on the projected screen, clean the inside of the projector with the supplied blower.

Using the supplied blower and the Cleaning function in the Setting menu, you can blow dusts away in the projector.

NOTE

- The dust might not be taken away completely with these steps. In that case, contact the dealer where you purchased the projector or the service center.



CAUTION



PROHIBITED

CAUTION IN USING THE BLOWER AND THE NOZZLE

- When using the blower, turn over the projector.
- Use only supplied blower and nozzle to keep the projector from being out of order or damaging. We could not guarantee the malfunction or breakage caused by using unsupplied tools.
- Do not use a commercially available air spray not to cause malfunction of internal parts with the cool air.
- Put the projector on a soft cloth not to scratch the surface.
- Open the hole cover only when you clean the inside of the projector.
- Do not pull the hole cover strongly.
- Do not look into the holes. Strong light could damage your eyes. (Do not look into Air intake vent and Exhaust vent, either.)
- Use the blower and the nozzle only to clean the projector. Do not try to use them to another purpose. Do not use the blower and nozzle to a man (especially eyes, mouth or ear and so on). Be careful not children put the blower and nozzle into their mouths or swallow them.
- Do not try to pull the nozzle out from the blower. If the nozzle happened to pull off, put it back into the blower.

When you find something unusual (smoke, strange sound, abnormal odor and so on) while you are cleaning, turn off and unplug the projector immediately, then call the dealer you purchased it or service center.

If the nozzle pulled off....

The nozzle has stoppers. Put the stopper side of the nozzle in the blower. Put the nozzle firmly in the blower until the stoppers become invisible.

When putting the nozzle in the blower, hold the stopper side not to break the nozzle.

Make sure not to force the nozzle to pull off from the blower.

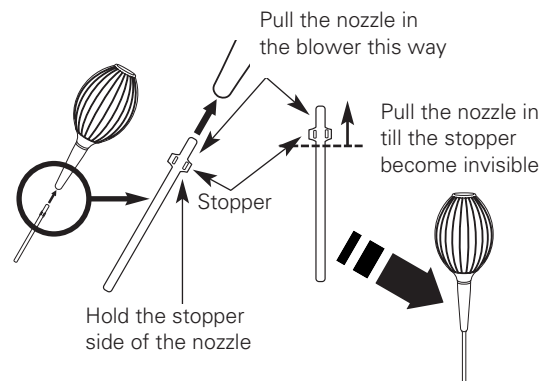

Clean with using the cleaning function in the Setting menu

- 1** Press MENU button to display the On-Screen Menu and select the Setting menu by pressing the Point Up/Down button. Then press Point Right button to enter the sub-menu.
 - 2** Press Point Up/Down button to select the Cleaning function then press SELECT button to select the item.
 - 3** The image is blacked out temporary.
 - 4** Turn over the projector then pull one of the hole covers upward gently.
 - 5** Put the blower nozzle in the hole.
 - 6** While watching the position of the dust on the screen, blow air into the projector by the blower.
 - 7** When finishing, pull the blower out and put the hole cover back tightly.
 - 8** Turn over the projector again, then press any button on the top control or on the remote control to cancel the Cleaning function.
- * Do not open the bottom cover except for when you clean the inside of the projector.
Especially while operating the projector, the optical parts could damage.

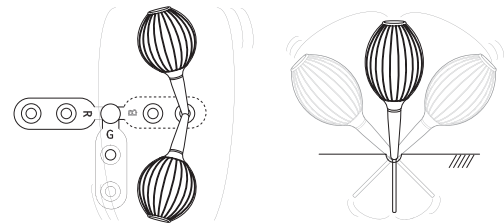
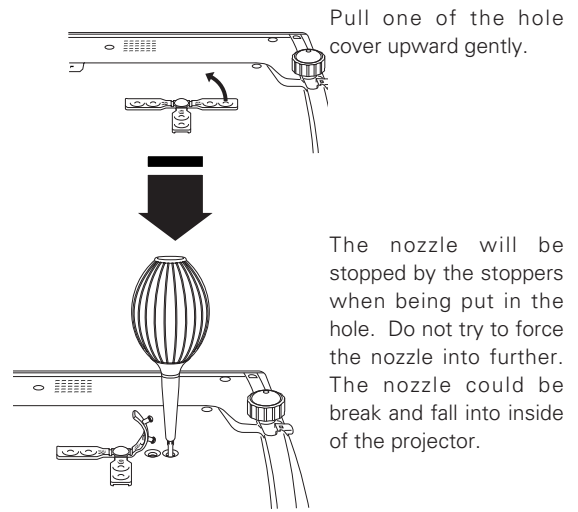

When cleaning, wave the nozzle inside of the projector back and forth.
(Do not try to force the nozzle to bend.)

 Use only supplied blower and nozzle.
Do not use a commercially available air spry not to cause malfunction of internal parts with the cool air. We could not guarantee the malfunction of breakage by using unsupplied tools.

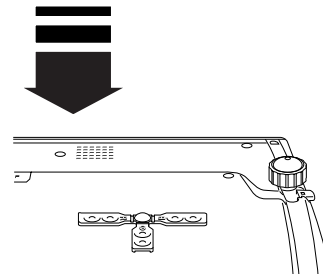

Which hole to put the nozzle in?

When you look at the screen

- When red spots (dust) are the most remarkable, put the nozzle in the R panel cleaning holes.
- When Green spots (dust) are the most remarkable, put the nozzle in the G panel cleaning holes.
- When Blue spots (dust) are the most remarkable, put the nozzle in the B panel cleaning holes.

When putting back the hole cover, starts from the outside hole to make the operation easier and prevent the hole cover from damaging.

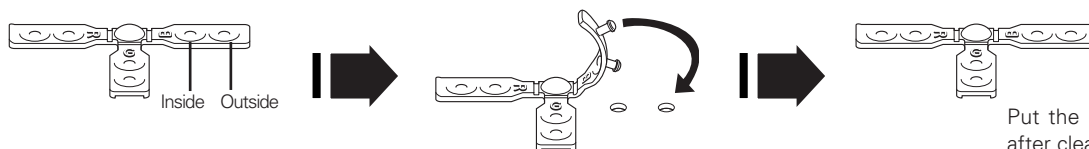

Cleaning the Air Filter

The air filters prevent dust from accumulating on the surface of the optical elements inside the projector. Should the air filters become clogged with dust particles, it will reduce cooling fans' effectiveness and may result in internal heat build up and adversely affect the life of the projector. Clean the air filters according to the following steps below.

- 1** Turn off the projector and disconnect the AC power cord from the AC outlet.
- 2** Turn over the projector. Put the projector on a soft cloth not to scratch the surface.

Cleaning the Air Filter 1

- 3** Push the latch and lift the air filter. Do not try to pull the delicate filter part.
- 4** Pull the Air Filter horizontally not to break the inside latch.
- 5** Remove dust and dirt with a soft brush or vacuum cleaner. Be careful not to damage the air filter and do not clean the air filter with water. Clean the air intake vent with a vacuum cleaner at the same time.
- 6** Put the air filter back into the position with pushing the top of the tub. Do not push the delicate filter part. Make sure that the air filters are properly and fully inserted.

Cleaning the Air Filter 2

- 3** Pull the latches on both edges upward.
- 4** Remove dust and dirt with a soft brush or vacuum cleaner. Be careful not to damage the air filters and do not clean the air filters with water. When there is much dust and dirt on the air filter, replace it with a new one. (See next page for replacing the air filter.)
- 5** Put the air filters back into position. Make sure that the air filters are properly and fully inserted.



CAUTION

Do not operate the projector with the air filter removed. Dust may accumulate on the LCD panel and the projection mirror degrading picture quality.

Do not put small parts into the air intake vents. It may result in malfunction of the projector.

RECOMMENDATION

We recommend avoiding dusty/smoky environments when operating the projector. When using under dusty or smoky conditions, dust may accumulate on a lens, LCD panels, or optical elements inside the projector. This condition may degrade the quality of a projected image.

When the above symptoms are noticed, contact your authorized dealer or service station for proper cleaning.

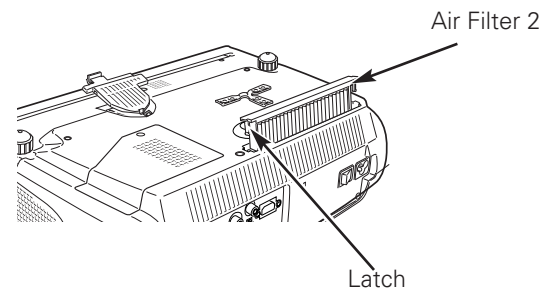
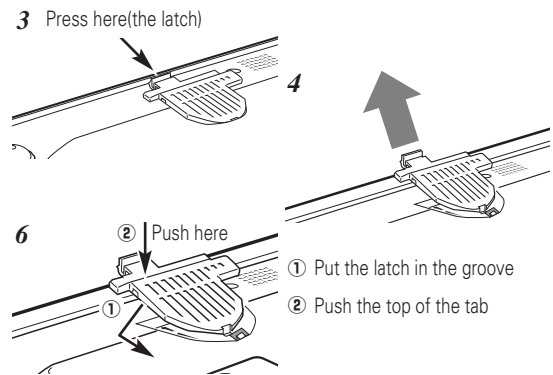
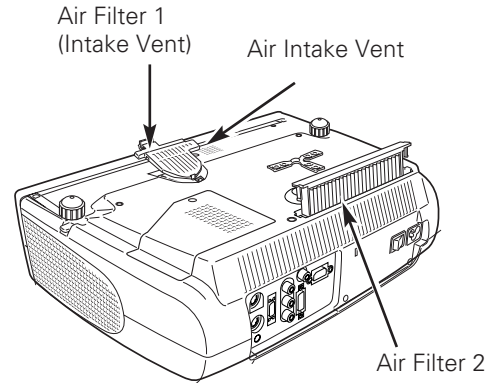

Replacing the Air Filter

When there is much dust and dirt on the air filter, replace it with a new one following the steps below.

- 1** After removing the air filter from the projector as described above, remove the replacement filter from the holder.
- 2** Holds the air filter with both hands, and remove the replacement filter by pulling it up.
- 3** Install a new replacement filter and put the air filter back into the projector.

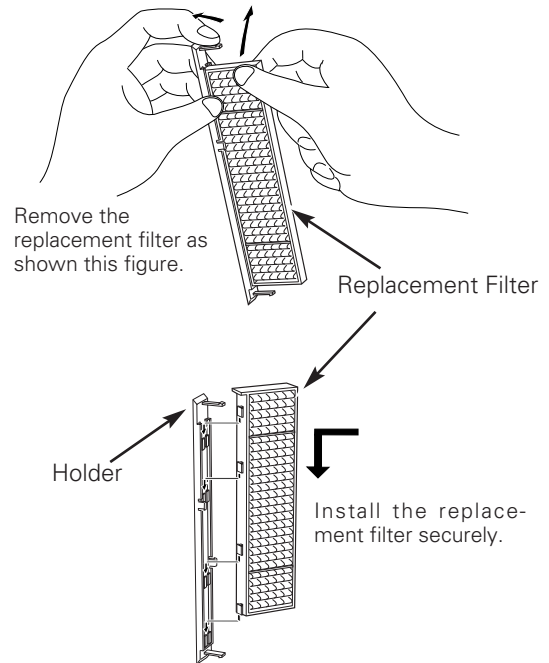

Cleaning the Projection Lens

Follow these steps to clean the projection lens.

- 1** Disconnect the AC power cord before cleaning.
- 2** Softly wipe the projection lens with a cleaning cloth that contains a small amount of non-abrasive camera lens cleaner, or use lens cleaning paper or a commercially available air blower to clean the lens. Avoid using an excessive amount of cleaner. Abrasive cleaners, solvents, or other harsh chemicals might scratch the surface.
- 3** When the projector is not in use, replace the lens cover.

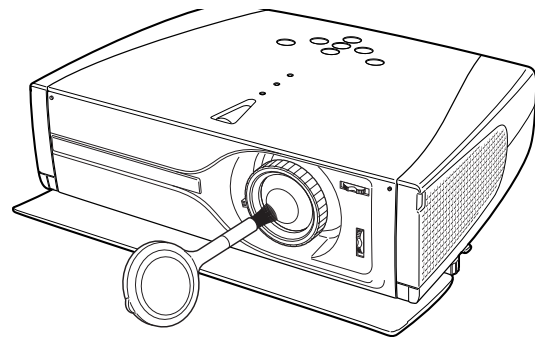

Cleaning the Projector Cabinet

Follow these steps to clean the projector cabinet.

- 1** Disconnect the AC power cord before cleaning.
- 2** Softly wipe the projector body with a soft, dry cleaning cloth. When it is heavily soiled, use a small amount of mild detergent and finish with a soft, dry cleaning cloth. Avoid using an excessive amount of cleaner. Abrasive cleaners, solvents, or other harsh chemicals might scratch the surface.
- 3** When the projector is not in use, put the projector in the carrying case to protect it from dust and scratches.

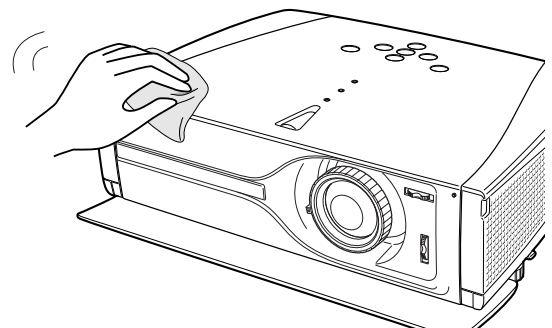

Lamp Replacement

When the life of the projection lamp of this projector draws to an end, the LAMP REPLACE indicator lights yellow. If this indicator lights yellow, replace the lamp with a new one promptly.

This indicator lights yellow when the life of the projection lamp draws to an end.

Top Control

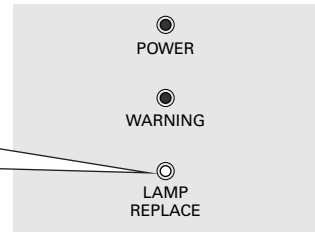

CAUTION

Allow a projector to cool, for at least 45 minutes before you open the Lamp cover. The inside of the projector can become very hot.



CAUTION

For continued safety, replace with a lamp of the same type. Do not drop a lamp or touch a glass bulb! The glass can shatter and may cause injury.

Follow these steps to replace the lamp.

- 1** Turn off the projector and disconnect the AC plug. Allow the projector to cool for at least 45 minutes.
- 2** Turn over the projector. Loosen the screw with a screwdriver, and remove the lamp cover.
- 3** Loosen 2 screws of the lamp with a screwdriver and pull out the lamp by grasping the handle.
- 4** Replace the lamp with a new one and tighten the 2 screws back into position. Make sure that the lamp is set properly. Replace the lamp cover and tighten the screw.
- 5** Connect the AC power cord to the projector and turn on the projector.
- 6** **Reset the Lamp replace counter.**
See "Lamp Replace Counter" on the next page .

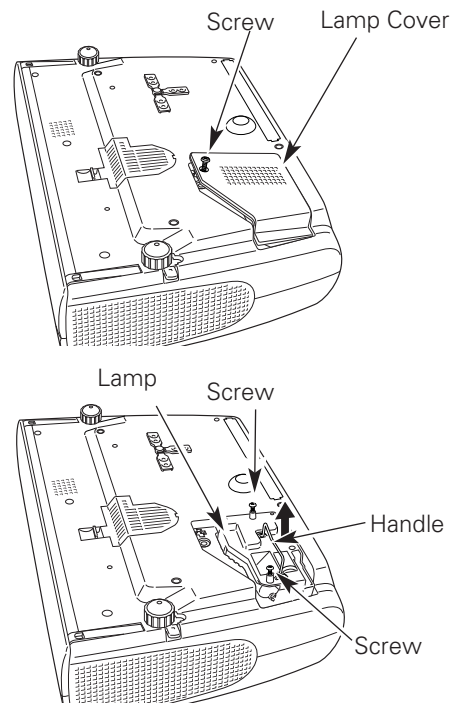

ORDER REPLACEMENT LAMP

Replacement lamp can be ordered through your dealer. When ordering a projection lamp, give the following information to the dealer.

- **Model No. of your projector** : **PLV-Z3**
- **Replacement Lamp Type No.** : **POA-LMP86**
(Service Parts No. 610 317 5355)

Lamp Replace Counter

Be sure to reset the lamp replace counter after the lamp is replaced. When the lamp replace counter is reset, the LAMP REPLACE indicator stops lighting.

- 1 Turn the projector on, press the MENU button, and the On-Screen Menu will appear. Select the Setting Menu with the Point Up/Down button and press the Point Right button to enter the sub-menu.
- 2 Select the Lamp counter reset item and then press the SELECT button. The message "Lamp replace counter Reset?" is displayed. Choose [Yes] and then press the SELECT button.
- 3 Another confirmation dialog box appears and choose [Yes] to reset the Lamp replace counter.

Lamp counter reset

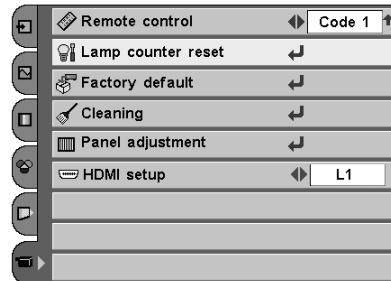

NOTE

- Do not reset the Lamp replace counter without implementation of lamp replacement. Be sure to reset the Lamp replace counter only after replacing the lamp.



LAMP HANDLING PRECAUTIONS

This projector uses a high-pressure lamp which must be handled carefully and properly. Improper handling may result in accidents, injury, or create a fire hazard.

- Lamp lifetime may differ from lamp to lamp and according to the environment of use. There is no guarantee of the same lifetime for each lamp. Some lamps may fail or terminate their lifetime in a shorter period of time than other similar lamps.
- If the projector indicates that the lamp should be replaced, i.e., if the LAMP REPLACE indicator lights up, replace the lamp with a new one IMMEDIATELY after the projector has cooled down. (Follow carefully the instructions in the Lamp Replacement section of this manual.) Continuous use of the lamp with the LAMP REPLACE indicator lighted may increase the risk of lamp explosion.
- A Lamp may explode as a result of vibration, shock or degradation as a result of hours of use as its lifetime draws to an end. Risk of explosion may differ according to the environment or conditions in which the projector and lamp are being used.

IF A LAMP EXPLODES, THE FOLLOWING SAFETY PRECAUTIONS SHOULD BE TAKEN.

If a lamp explodes, disconnect the projector's AC plug from the AC outlet immediately. Contact an authorized service station for a checkup of the unit and replacement of the lamp. Additionally, check carefully to ensure that there are no broken shards or pieces of glass around the projector or coming out from the cooling air circulation holes. Any broken shards found should be cleaned up carefully. No one should check the inside of the projector except those who are authorized trained technicians and who are familiar with projector service. Inappropriate attempts to service the unit by anyone, especially those who are not appropriately trained to do so, may result in an accident or injury caused by pieces of broken glass.

Appendix

Troubleshooting

Before calling your dealer or service center for assistance, check the items below once again.

- Make sure you have properly connected the projector to peripheral equipment as described in "Connecting to Video Equipment" and "Connecting to a Computer" on page 16-18.
- Make sure all equipment is connected to AC outlet and the power is turned on.
- When you operate the projector with a computer and it does not project an image, restart the computer.

Problem: - Try these solutions.

No power

- Plug the power cord of the projector into the AC outlet.
- See if the front cover is open and the POWER indicator lights red.
- See if the Main On/Off switch is on.
- Wait 90 seconds after the projector is turned OFF when turning the projector back on. The projector can be turned on after the POWER indicator turns red. (See "Turning Off the Projector" on page 19.)
- Check the WARNING indicator. If the WARNING indicator lights red, the projector cannot be turned on. (See "Warning Indicator" on page 45.)
- Check the projection lamp. (See page 49.)
- Check the projector is installed on the flat surface.

Image is out of focus.

- Adjust focus of the projector.
- Provide proper distance between the projector and the projection screen. (See page 13.)
- Check the projection lens to see if it needs cleaning. (See page 49.)
- Moving the projector from a cool temperature location to a warm temperature location may result in moisture condensation on the projection lens. In such an event, leave the projector OFF and wait until condensation disappears.

No image

- Check the connection between video equipment or your computer and the projector.
- See if the input signal is correctly output from your computer. Some laptop computers may need changing the setting for monitor output when you are connecting a laptop computer. See your computer's owner's manual for setting.
- It takes about 20 seconds to display an image after turning on the projector.
- See if the selected system is corresponding with video equipment or your computer.
- Select correct input source once again through menu operation.
- Make sure the temperature is not out of the Operating Temperature (5°C ~ 35°C).

Image is Left/Right reversed.

- Check the Mounting / Rear item. (See "Setting" on page 42.)

Image is Top/Bottom reversed.

- Check the Mounting item. (See "Setting" on page 42.)

Some displays are not seen during the Operation.

- Check the Display item. (See "Setting" on page 41 .)

The Remote Control does not work.

- Check the batteries.
- Make sure no obstruction is between the projector and remote control.
- Make sure you are not too far from the projector when using the remote control. Maximum operating range is 16.4' (5m).
- Make sure the code of the remote control is conformed to that of the projector. (See page 43)































WARNING :

High voltages are used to operate this projector. Do not attempt to open the cabinet.





If problems still persist after following all operating instructions, contact the dealer where you purchased the projector or the service center. Give the model number and explain about the problem. We will advise you how to obtain service.

Indicators and Projector Condition

Check the indicators for projector condition.

Indicators			Projector Condition
POWER red/green/ orange	WARNING red	LAMP REPLACE yellow	
			The Main On/Off switch is off or the AC power cord is unplugged.
			The projector is preparing for stand-by. Or the projection lamp is being cooled down. The projector cannot be turned on until cooling is completed.
			The projector is ready to be turned on with the POWER ON-OFF button.
			The projector is operating normally.
			The projector is in the Power management mode.
			The temperature inside the projector is abnormally high. The projector cannot be turned on. When the projector is cooled down enough and the temperature returns to normal, the POWER indicator lights red and the projector can be turned on. (The WARNING indicator keeps flashing.) Check and clean the Air filter.
			The projector has been cooled down enough and the temperature returns to normal. When turning on the projector, the WARNING indicator stops flashing. Check and clean the air filter.
			The projector detects an abnormal condition and cannot be turned on. Unplug the AC power cord and plug it again to turn on the projector. If the projector is turned off again, disconnect the AC power cord and contact the dealer or the service center for service and checkup. Do not leave the projector on. It may cause electric shock or a fire hazard.
			The lamp does not light because malfunction occurs or the lamp life comes to an end.
			The front cover is closed.

 ●●● lights green.  ●●● flashes green.  ●●● lights orange.

 ●●● lights red.  ●●● flashes red.  ●●● flashes yellow.  ●●● off

*When the life of the projection lamp draws to an end, the LAMP REPLACE indicator lights yellow. When this indicator lights yellow, replace the projection lamp with a new one promptly. Reset the Lamp replace counter after replacement of the lamp. See page 50 and 51.

Menu Tree

Video Input/Computer Input

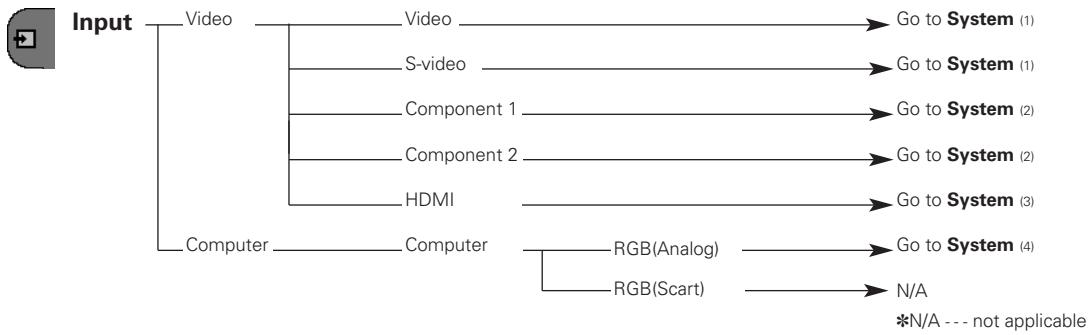

Video Input

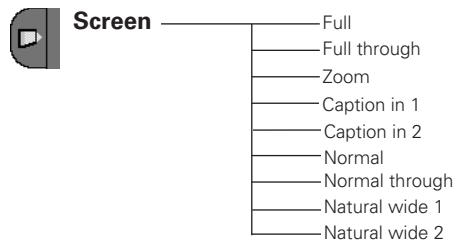
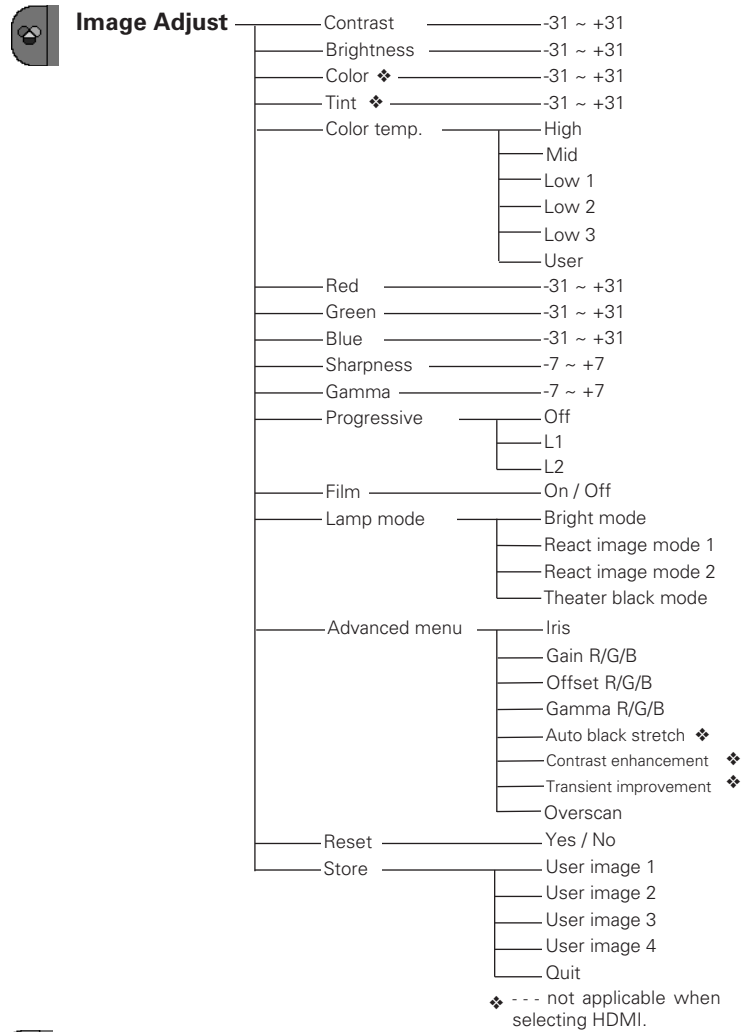
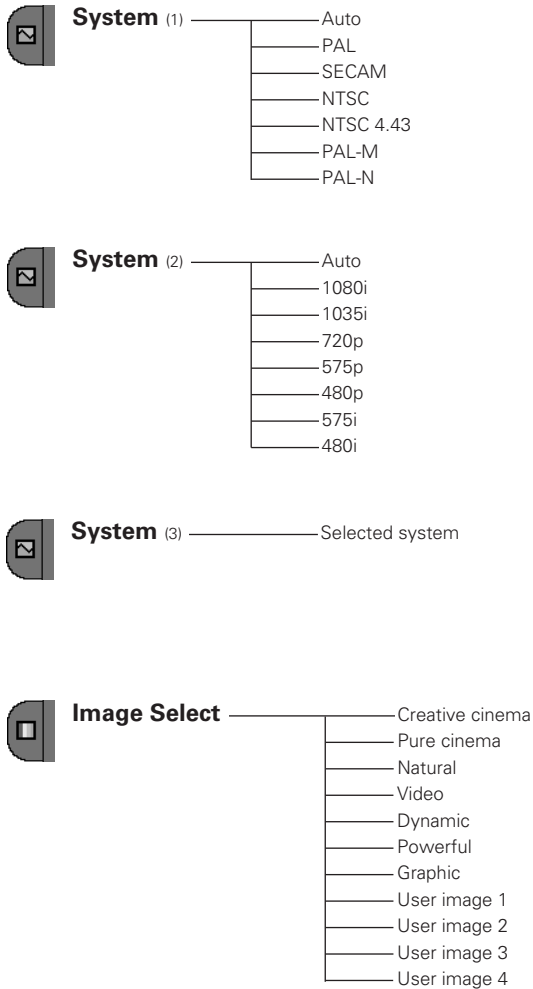

Computer Input

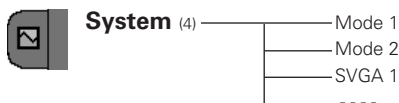

*Systems displayed in the System Menu vary depending on an input signal.

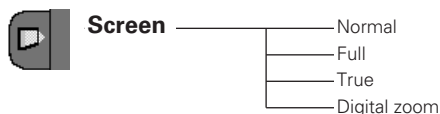
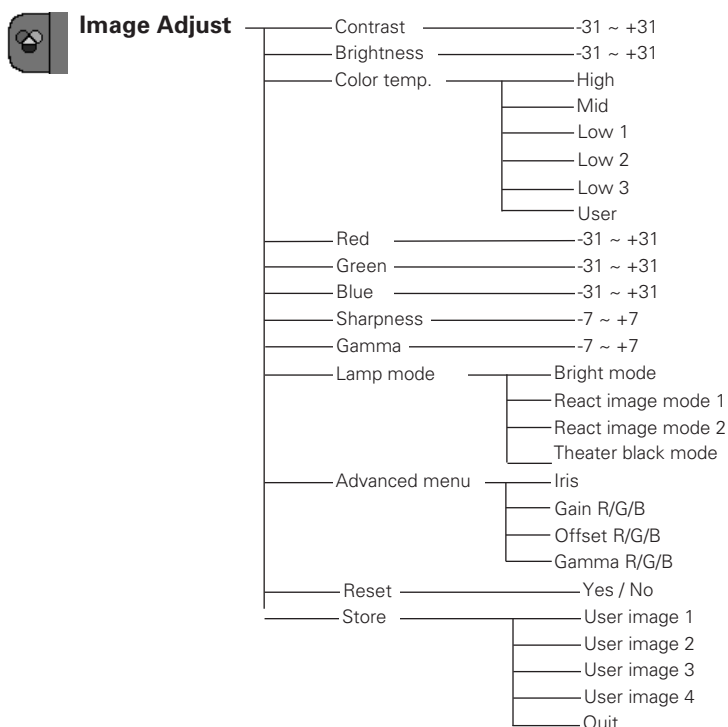
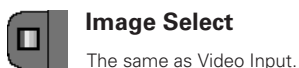
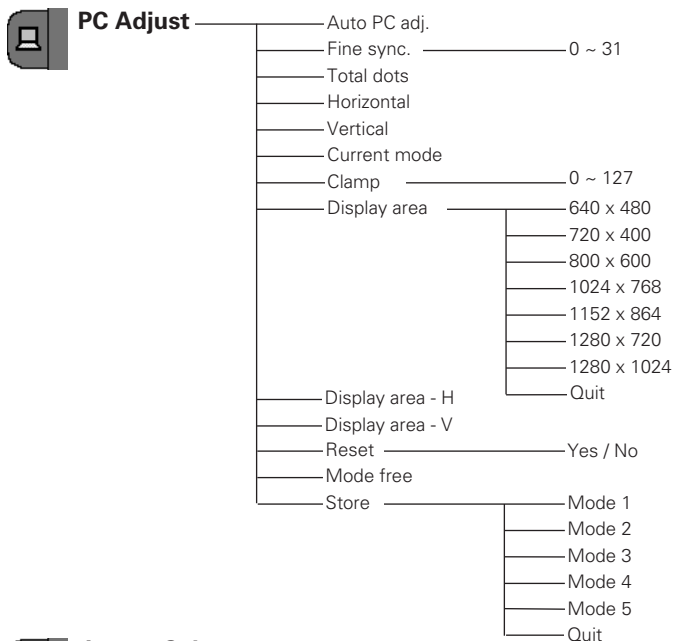

Setting

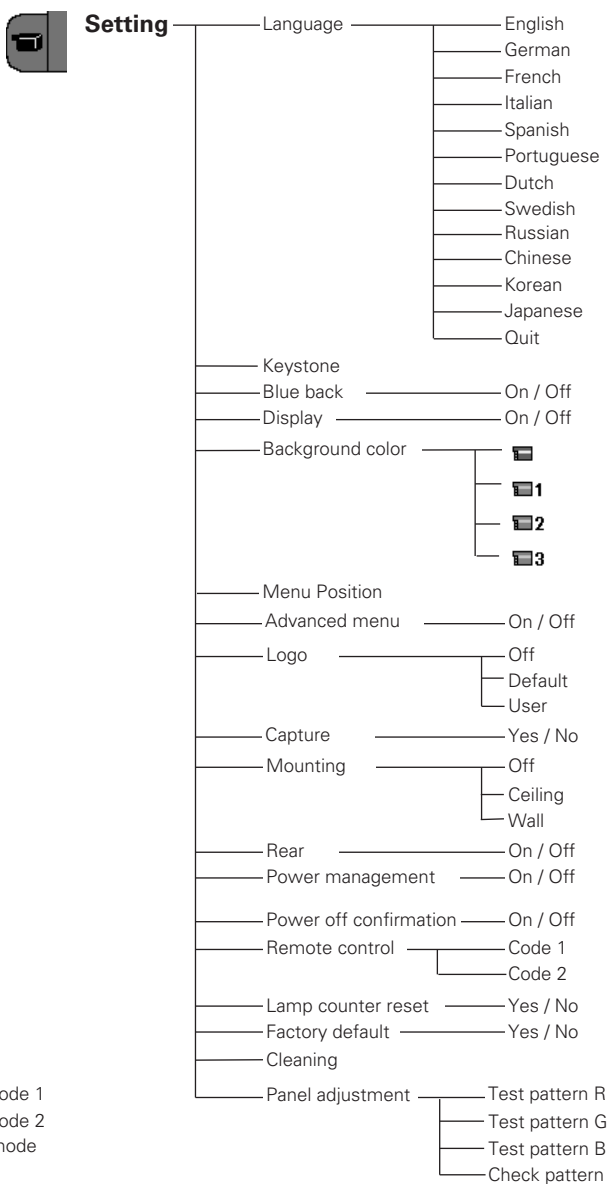

Compatible Computer Specifications

Basically this projector can accept the signal from all computers with the V, H-Frequency below mentioned and less than 100 MHz of Dot Clock.

ON-SCREEN DISPLAY	RESOLUTION	H-Freq. (kHz)	V-Freq. (Hz)	ON-SCREEN DISPLAY	RESOLUTION	H-Freq. (kHz)	V-Freq. (Hz)
VGA 1	640 x 480	31.47	59.88	XGA 8	1024 x 768	63.48	79.35
VGA 2	720 x 400	31.47	70.09	XGA 9	1024 x 768	36.00	87.17 (Interlace)
VGA 3	640 x 400	31.47	70.09	XGA 10	1024 x 768	62.04	77.07
VGA 4	640 x 480	37.86	74.38	XGA 11	1024 x 768	61.00	75.70
VGA 5	640 x 480	37.86	72.81	XGA 12	1024 x 768	35.522	86.96 (Interlace)
VGA 6	640 x 480	37.50	75.00	XGA 13	1024 x 768	46.90	58.20
VGA 7	640 x 480	43.269	85.00	XGA 14	1024 x 768	47.00	58.30
MAC LC13	640 x 480	34.97	66.60	XGA 15	1024 x 768	58.03	72.00
MAC 13	640 x 480	35.00	66.67	MAC 19	1024 x 768	60.24	75.08
575i	————	15.63	50.00 (Interlace)	MAC 21	1152 x 870	68.68	75.06
480i	————	15.34	60.00 (Interlace)	SXGA 1	1152 x 864	64.20	70.40
SVGA 1	800 x 600	35.16	56.25	SXGA 11	1152 x 900	61.20	65.20
SVGA 2	800 x 600	37.88	60.32	SXGA 13	1280 x 1024	50.00	86.00 (Interlace)
SVGA 3	800 x 600	46.875	75.00	SXGA 14	1280 x 1024	50.00	94.00 (Interlace)
SVGA 4	800 x 600	53.674	85.06	SXGA 17	1152 x 900	61.85	66.00
SVGA 5	800 x 600	48.08	72.19	SXGA 18	1280 x 1024	46.43	86.70 (Interlace)
SVGA 6	800 x 600	37.90	61.03	WXGA 1	1366 x 768	48.36	60.00
SVGA 7	800 x 600	34.50	55.38	WXGA 2	1360 x 768	47.70	60.00
SVGA 8	800 x 600	38.00	60.51	WXGA 3	1376 x 768	48.36	60.00
SVGA 9	800 x 600	38.60	60.31	480p	————	31.47	59.88
SVGA 10	800 x 600	32.70	51.09	575p	————	31.25	50.00
SVGA 11	800 x 600	38.00	60.51	720p	————	45.00	60.00
MAC 16	832 x 624	49.72	74.55	720p	————	37.50	50.00
XGA 1	1024 x 768	48.36	60.00	1035i	————	33.75	60.00 (Interlace)
XGA 2	1024 x 768	68.677	85.00	1080i	————	33.75	60.00 (Interlace)
XGA 3	1024 x 768	60.023	75.03	1080i	————	28.125	50.00 (Interlace)
XGA 4	1024 x 768	56.48	70.07				
XGA 5	1024 x 768	60.31	74.92				
XGA 6	1024 x 768	48.50	60.02				
XGA 7	1024 x 768	44.00	54.58				

When an input signal is digital from HDMI terminal, refer to the chart below.

ON-SCREEN DISPLAY	RESOLUTION	H-Freq. (kHz)	V-Freq. (Hz)	ON-SCREEN DISPLAY	RESOLUTION	H-Freq. (kHz)	V-Freq. (Hz)
D-VGA	640 x 480p	————	59.94/60	D-720p	1280 x 720p	————	59.94/60
D-480i	720 x 480i	————	59.94/60	D-720p	1280 x 720p	————	50.00
D-525i	720 x 575i	————	50.00	D-1080i	1920 x 1080i	————	59.94/60
D-480p	720 x 480p	————	59.94/60	D-1080i	1920 x 1080i	————	50.00
D-575p	720 x 575p	————	50.00				

NOTE

● You might be able to project images even when signals other than above are input. But in that case, functions of the projector could be limited.

Technical Specifications

Projector Type	Multimedia Projector
Dimensions (W x H x D)	14.13" x 4.59" x 10.77" (359mm x 116.7mm x 273.5mm) (not including raised portions)
Net Weight	9.0 lbs (4.1 kg)
LCD Panel System	0.7" wide TFT Active Matrix type, 3 panels
Panel Resolution	1280 x 720 dots
Number of Pixels	2,764,800 (1280 x 720 x 3 panels)
Color System	PAL, SECAM, NTSC, NTSC4.43, PAL-M, and PAL-N
High Definition TV Signal	480i, 480p, 575i, 575p, 720p, 1035i, and 1080i
Scanning Frequency	H-sync. 15 ~ 80 KHz, V-sync. 50 ~ 100 Hz
Projection Image size (Diagonal)	Adjustable from 31" to 200"
Projection Lens	F 2.04 ~ 2.54 lens with f 21.5 mm ~ 27.7 mm with manual zoom and focus
Throw Distance	3.9' ~ 20.0' (1.2 m ~ 6.1 m)
Projection Lamp	135 W
Video Input Jacks	RCA Type x 1 (Video), RCA Type x 3(Y, Pb/Cb, Pr/Cr) x 2 and Mini DIN 4 pin x 1 (S-video)
Computer Input Terminal	(VGA) HDB 15 Terminal x 1
HDMI Input Terminal	HDMI terminal 19 pin x 1
Service Port Connector	Mini DIN 8 pin x 1
Feet Adjustment	0° to 11.8°
Voltage and Power Consumption	AC 100 ~ 120 V (2.4 A Max. Ampere), 50 / 60 Hz (The U.S.A. and Canada) AC 200 ~ 240 V (1.3 A Max. Ampere), 50 / 60 Hz (Continental Europe and The U.K.)
Operating Temperature	41 °F ~ 95 °F (5 °C ~ 35 °C)
Storage Temperature	14 °F ~ 140 °F (-10 °C ~ 60 °C)
Remote Control	Power Source : AA, UM3 or LR06 1.5V ALKALINE Type x 2 Operating Range : 16.4' (5m) / ±30° Dimensions : 1.97" x 1.06" x 6.61" (50mm x 27mm x 168mm) Net Weight : 4.4oz (126g) (including batteries)
Accessories	Owner's Manual AC Power Cord Remote Control and Batteries Video Cable

- The specifications are subject to change without notice.
- LCD panels are manufactured to the highest possible standards. Even though 99.99% of the pixels are effective, a tiny fraction of the pixels (0.01% or less) may be ineffective by the characteristics of the LCD panels.
- The On-Screen Menu and figures in this manual may differ slightly from the product.



This symbol on the nameplate means the product is Listed by Underwriters Laboratories Inc. It is designed and manufactured to meet rigid U.L. safety standards against risk of fire, casualty and electrical hazards.



The CE Mark is a Directive conformity mark of the European Community (EC).



Pixelworks ICs used.

Dimensions

Unit : inch (mm)

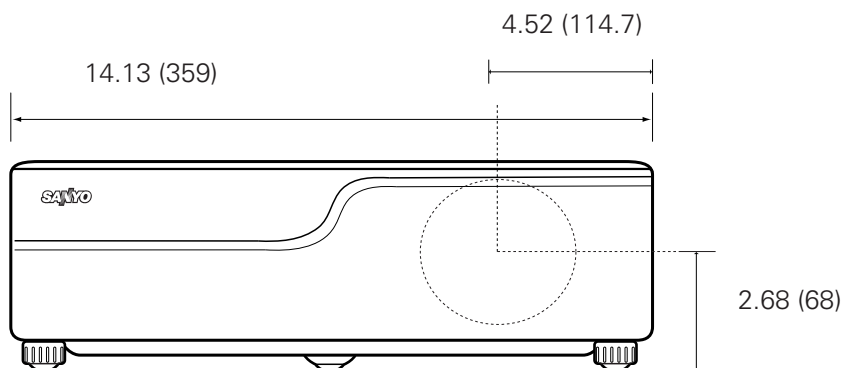

11.8° (Max.)

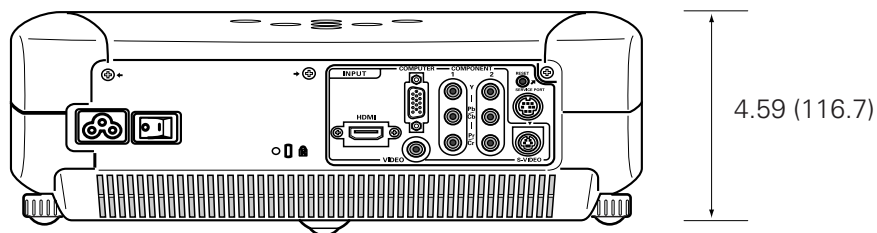
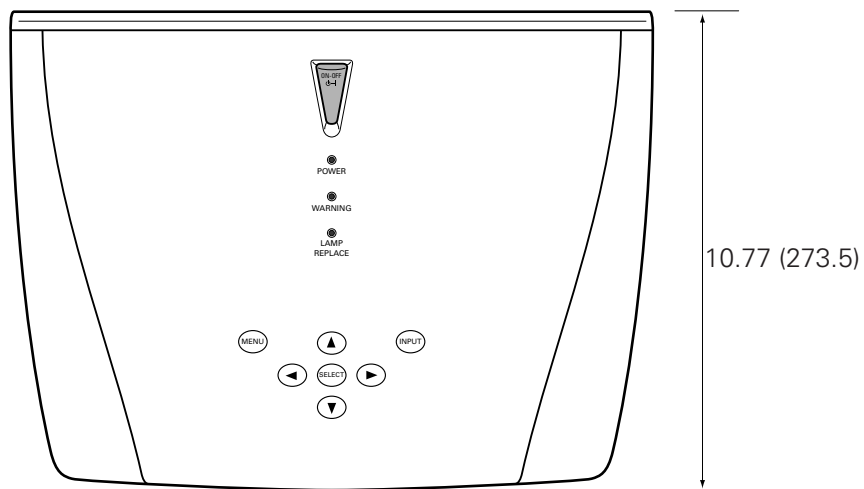
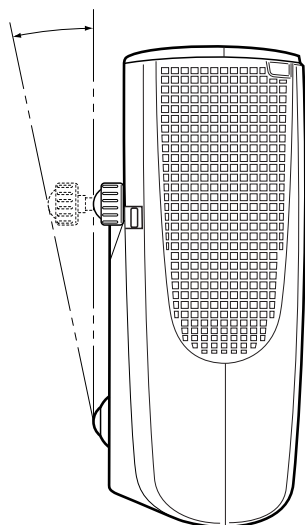

Configurations of Terminal

Video terminal

Terminal : HDMI

Pin Configuration

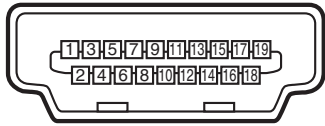

19 Pin Type A

1	TMDS Data 2+ Input	11	Ground (TMDS Clock)
2	Ground (TMDS Data 2)	12	TMDS Clock- Input
3	TMDS Data 2- Input	13	----
4	TMDS Data 1+ Input	14	----
5	Ground (TMDS Data 1)	15	SCL
6	TMDS Data 1- Input	16	SDA
7	TMDS Data 0+ Input	17	Ground(DDC/CEC)
8	Ground (TMDS Data 0)	18	+5V Pwer
9	TMDS Data 0- Input	19	Plug insetr detection
10	TMDS Clock+ Input		

Computer terminal

Terminal : VGA

Pin Configuration

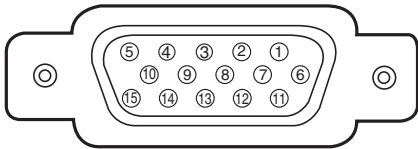

1	Red (R/Cr) Input / Output	9	----
2	Green (G/Y) Input / Output	10	Ground (Vert.sync.)
3	Blue (B/Cb) Input / Output	11	Ground / ----
4	----	12	----
5	Ground (Horiz.sync.)	13	Horiz. sync. Input/Output (Composite H/V sync.)
6	Ground (Red)	14	Vert. sync.
7	Ground (Green)	15	----
8	Ground (Blue)		

Optional Parts

The parts listed below are optionally supplied. When ordering those parts, give the name and Type No. to the sales dealer.

- **Wall Anchor Kit** **Type No. : POA-CH-EX01**
- **HDMI Cable** **Type No. : POA-CA-HDMI**
- **Component Cable (32.8'/10m)** **Type No. : POA-CA-COMP10**
- **Scart-VGA Cable** **Type No. : POA-CA-SCART**

(This cable is used for RGB Scart 21-Pin Video output of video equipment.)

